

# *CASTI Guidebook to* **ASME Section IX** **Welding Qualifications**

CASTI Publishing Inc.  
10566 - 114 Street  
Edmonton, Alberta T5H 3J7 Canada  
Tel:(780) 424-2552 Fax:(780) 421-1308

Third Edition on CD-ROM™



Search

Subject Index

Table of Contents

E-Mail: [casti@casti.ca](mailto:casti@casti.ca)  
Internet Web Site: [www.casti.ca](http://www.casti.ca)

# ***CASTI Guidebook to*** **ASME Section IX -** **Welding Qualifications**

(Covering the 2001 Code Edition)

**Third Edition**

***CASTI* Guidebook Series - Vol. 2**

**Michael J. Houle**  
**Richard D. McGuire**

Executive Editor  
John E. Bringas, P.Eng.

**Published By:**



CASTI Publishing Inc.  
10566 - 114 Street  
Edmonton, Alberta, T5H 3J7, Canada  
Tel: (780) 424-2552 Fax: (780) 421-1308  
E-mail: [casti@casti.ca](mailto:casti@casti.ca)  
Web Site: [www.casti.ca](http://www.casti.ca)

ISBN 1-894038-64-9  
Printed in Canada

# **CASTI PUBLICATIONS**

## ***CASTI GUIDEBOOK SERIES™***

- Volume 1 - *CASTI* Guidebook to ASME Section II, B31.1 & B31.3 - Materials Index
- Volume 2 - *CASTI* Guidebook to ASME Section IX - Welding Qualifications
- Volume 3 - *CASTI* Guidebook to ASME B31.3 - Process Piping
- Volume 4 - *CASTI* Guidebook to ASME Section VIII Div. 1 - Pressure Vessels
- Volume 5 - Plant Project Engineering Guidebook: for Mechanical and Civil Engineers

## ***CASTI CORROSION SERIES™***

- Volume 1 - Handbook of Cladding Technology
- Volume 2 - Handbook of Stainless Steels & Nickel Alloys
- Volume 3 - Handbook of Corrosion in Soils
- Volume 4 - Corrosion Control

## ***CASTI METALS DATA BOOK SERIES™***

- CASTI* Metals Black Book™ - North America Ferrous Data
- CASTI* Metals Black Book™ - European Ferrous Data
- CASTI* Metals Red Book™ - Nonferrous Metals
- CASTI* Metals Blue Book™ - Welding Filler Metals

First printing of Third Edition, January 2002

ISBN 1-894038-64-9      Copyright © 1999, 2000, 2001, 2002

All rights reserved. No part of this book covered by the copyright hereon may be reproduced or used in any form or by any means - graphic, electronic, or mechanical, including photocopying, recording, taping, or information storage and retrieval systems without the written permission of the publisher.

## ***FROM THE PUBLISHER***

### ***IMPORTANT NOTICE***

The material presented herein has been prepared for the general information of the reader and should not be used or relied upon for specific applications without first securing competent technical advice. Nor should it be used as a replacement for current complete engineering codes and standards. In fact, it is highly recommended that the appropriate current engineering codes and standards be reviewed in detail prior to any decision-making.

While the material in this book was compiled with great effort and is believed to be technically correct, *CASTI* Publishing Inc. and its staff do not represent or warrant its suitability for any general or specific use and assume no liability or responsibility of any kind in connection with the information herein.

Nothing in this book shall be construed as a defense against any alleged infringement of letters of patents, copyright, or trademark, or as defense against liability for such infringement.

### ***OUR MISSION***

Our mission at *CASTI* Publishing Inc. is to provide industry and educational institutions with practical technical books at low cost. To do so, each book must have a valuable topic, be current with today's technology, and be written in such a manner that the reader considers the book to be a reliable source of practical answers that can be used on a regular basis. The *CASTI Guidebook Series*<sup>™</sup> to the ASME Welding Qualifications Code has been designed to meet these criteria.

We would like to hear from you. Your comments and suggestions help us keep our commitment to the continuing quality of the *CASTI Guidebook Series*<sup>™</sup>.

All correspondence should be sent to the authors in care of:

*CASTI* Publishing Inc.  
10566 - 114 Street  
Edmonton, Alberta, T5H 3J7  
Canada,

tel: (780) 424-2552, fax: (780) 421-1308  
E-mail: casti@casti.ca  
Internet Web Site: <http://www.casti.ca>

## PREFACE

The *ASME Boiler & Pressure Vessel Code*, Section IX is not an easy document to use. I have worked with Section IX for nearly forty years and have been on the Section IX Subcommittee (SCIX) for nearly thirty years. I have learned a good deal about the difficulties of using Section IX by reviewing the numerous inquiries received by the Subcommittee IX and during many years of providing instruction to Code users. I have also learned by working with many other welding and construction codes throughout the world.

I have always had empathy for the Code users. The Code is not a “how-to” guide but rather is a minimum set of rules for the qualification of welders and procedures. The Code does not address all aspects of construction activities. It allows the Code user flexibility in the control of qualifications, and therefore the rules are presented in a general manner.

I have always wanted to write a book about Section IX. Having been on Subcommittee IX longer than anyone else, I feel compelled to write the book, in part, to preserve the historical perspective Section IX. But I also wanted to write the book for the many Code users who have not had the opportunity to attend and benefit from the Subcommittee IX meetings for the past 30 years. I feel I can give users the basis for a sound understanding of how to use Section IX.

Many Code users are specialists in various crafts and have a sincere desire to do everything correctly. Section IX is just one more set of rules in the paper work trail which must be integrated into their specialty. I have prepared this book for those Code users whose specialty is not welding. I hope the book is presented in a clear and concise manner, so those Code users can walk their way through some of their basic welding qualification requirements more easily. This book also has details and interpretations to provide clarity, even to the experienced Code user. Some Section IX rules, unfortunately, remain hidden in the Interpretations, which may not be readily accessible to the general public. This book looks beyond the specific words of the Code, recalling Interpretations when necessary, to provide guidance where even a close study may not produce a clear conclusion.

Joining pressure retaining metals by welding was first permitted in the ASME Boiler & Pressure Vessel Codes in 1935. Each code section committee formed its own rules for the qualification of welding procedure specifications and welders. In 1941, Subcommittee IX was formed as a joint committee of AWS and ASME personnel. The structure of the 1941 edition of Section IX was similar to the current edition. There were sixteen variables for the qualification of welding procedure specifications (WPS) and four variables for the qualification of the welder’s performance. There was a mandatory narrative WPS form which required the Code user to fill in the blanks. Those WPS form blanks were sequential and required the Code user to fill in the base metal preparation, cleaning, back gouging, peening, etc. One of the original committee members, George Fratcher, once said, “The 1941 Code was perfect. You qualified the variables on the WPS and if you changed anything, you had to requalify for the changed variables. The problem was, controlling minor variable changes was not practical nor enforceable.”

The WPS form was revised to a recommended form in 1952, and were finally put into a nonmandatory appendix. Nonessential variables were introduced in the 1974 rewrite of Section IX. The 1974 edition of Section IX stated that the purpose of the WPS was to provide directions for the welder to make the weld. The purpose of the procedure qualification record (PQR) was to demonstrate the properties of the weld under the conditions proposed in the WPS. The purpose of the welders performance qualification (WPQ) test was to demonstrate the welder's ability to deposit sound welds using a qualified WPS. Subcommittee IX clarified that changes in an essential variable on a WPS required a new PQR to support these changes. Subcommittee IX also clarified that a change in a nonessential variables required a revision to the WPS, but did not require a new PQR to support the change. The 1974 edition of the Code also removed those variables which affected the notch-toughness properties of a weldment and placed them in a separate listing as supplemental essential variables, required only for notch-toughness applications. The 1974 changes were practical and a great benefit to the Code user.

The 1998 edition of Section IX has more than 200 variables, many with multiple conditions, for 13 welding processes and special processes. This tremendous addition of processes and variables has been a conscious attempt to further clarify the Code for the user. It may be useful for the Code user to know that the many complicated aspects of the current edition were introduced to make welding qualifications easier. This guide has been prepared to help the Code user understand many of these complex conditions and variables.

Michael J. Houle

**TABLE OF CONTENTS**

1. Introduction	1
2. Welding Documentation Forms	13
3. Review of Article I – General, Article II – Procedure, and Article III – Performance	25
4. Review of Article IV – Welding Data	37
5. Sample WPS, PQR, and WPQ Documentation	75
6. How to Prepare and Review a WPS	85
7. How to Prepare and Review a PQR	109
8. Testing Requirements for Procedure Qualification	137
9. Checklist for WPS and PQR	155
10. How to Prepare and Review a WPQ	181
11. Testing and Examination Requirements for WPQ	211
12. Expiration, Revocation, Retests and Renewal of WPQ	225
13. Welding Variables for Welding Operators	235
14. Supplementary Essential Variables	239
15. Review of Article V – Standard Welding Procedures Specifications	257
16. Miscellaneous	271
Appendix 1 – Terms and Abbreviations	295
Appendix 2 – Engineering Data	297
Appendix 3 – International Standards Organizations, Technical Associations and Societies	315
Appendix 4 – Interpretations	321
Appendix 5 – Sample SWPS ANSI/AWS B21.1-1-026-94	367
Subject Index	381
Code Paragraph Index	389
ASME Interpretations Index	395

# Chapter 1

## INTRODUCTION

### Scope

Section IX of the ASME Boiler and Pressure Vessel Code is a standard, prepared by the American Society of Mechanical Engineers (ASME) Boiler and Pressure Vessel Committee. ASME standards have been adopted as law by most States, Provinces, some Cities, and by company policy, which makes it mandatory for these standards to be followed in the fabrication and repair of pressure retaining items.

Section IX specifies the requirements for the qualification of welders and the welding procedure specifications employed when welding in accordance with the ASME Boiler and Pressure Code, and the ASME B31 Code for Pressure Piping.

Qualification of welders and the welding procedure specifications they will use in code construction involves a great many factors that are difficult to outline in a code or standard. The CASTI Guidebook to ASME Section IX - *Welding Qualifications*, is a guide to the requirements of the ASME Boiler and Pressure Vessel Code Section IX - Welding and Brazing Qualifications.

**Note:** The Preface of Section IX contains an informative historical perspective on the development of the current code rules.

There are three steps involved in qualifying welders and welding procedure specifications for Code construction.

- The first step requires the Code user to prepare welding procedure specifications (WPS). The WPS must contain the minimum requirements that are specified by the reference code. The WPS is intended to provide guidance for welding by specifying ranges for each variable. The WPS must be supported by a procedure qualification record (PQR). See the second step and Chapter 6.
- The second step requires the Code user to qualify the WPS by welding procedure qualification test coupons. The Code user must record the variables and tests used, and must certify the tests and test results on a PQR. See Chapter 7.
- The third step requires the Code user to qualify the performance of the welders by welding performance qualification test coupons. The Code user must record the variables and tests used, specify the variable ranges qualified, and must certify the tests and tests results on a welders performance qualification (WPQ) record. See Chapter 10.

The majority of the rules in Section IX involve one of these three documents, the WPS, PQR or WPQ. The authors have found the biggest source of confusion with Section IX, is the mixing of the rules between these three documents. This guide uses four-column tables to outline how each topic, example, or application applies to the WPS, PQR, or WPQ. See Table 1.1. A given topic, example, or application may



apply to all three documents, while others may only apply to one or two of the documents. The user of this guide is advised to review and understand each of these documents, and always keep in mind which document is being addressed. See Table 1.2 for an overview of each of these three documents, and how they apply to a welding application.

Table 1.1 Basics For Welding - Before You Strike An Arc

<p><b>Welding Application</b></p>	<p><b>WPS</b></p> <p>Specify: Variable ranges Essential variables Nonessential variables</p>	<p><b>PQR</b></p> <p>Record: Actual variables Essential variables Tests and results</p>	<p><b>WPQ</b></p> <p>Record Actual variables Specify Ranges Qualified Tests and results</p>
<p><b>Example 1.1.1</b></p>			
<p><b>Step 1</b></p> <p>The following steps should be followed when the welding application specifies welding per ASME Section IX. The term Code user includes the manufacturer, contractor, assembler, or installer, the owner/user or the repair firm responsible for controlling the welding application.</p>	<p><b>Step 2</b></p> <p>QW-250 lists the essential and nonessential variables that must be specified on each Welding Procedure Specification (WPS) for each process. The Code user shall prepare a WPS to cover each application. Welding shall be done following the direction of a (WPS). Each WPS shall be supported by one or more PQR(s).</p>	<p><b>Step 3</b></p> <p>QW-250 lists the essential variables, by process for qualifying each WPS. The Code user must supervise the welding of the PQR test coupon following the variables of a WPS. The Code user must record each essential variable, tests, and the test results on a PQR form.</p>	<p><b>Step 4</b></p> <p>QW-350 lists the variables, by process for qualifying each welder's performance. The welder is qualified by welding a test coupon following a WPS. The Code user shall supervise this welding, record the variables, the tests, test results, and the ranges qualified on a WPQ form.</p>
<p><b>Step 5</b></p> <p>An Authorized Inspector shall verify that each WPS, for each welding application is properly prepared and supported by a valid PQR and that each welder to be used has been properly qualified in accordance with Section IX.</p> <p>The Authorized Inspector should document this concurrence prior to the start of any new construction or for repairs by welding.</p>	<p><b>Step 6</b></p> <p>The Code user must describe on a WPS the details to guide the welder on how each weld is to be made.</p> <p>The WPS shall specify an allowable range for each variable.</p> <p>The WPS shall be used to provide direction for the welder and to control each of the variables for each welding process used.</p>	<p><b>Step 7</b></p> <p>The Code user may perform the required tests, or testing may be subcontracted to a testing lab. The PQR is intended to prove weldability of the base metal, filler metal, and welding process combinations.</p> <p>The Code user in each case must certify the PQR thereby accepting responsibility for the results.</p>	<p><b>Step 8</b></p> <p>Test coupons shall be mechanically tested or examined by radiography. The tests and examinations may be subcontracted, but the WPQ must be certified by the Code user.</p> <p>The Code user shall maintain each welder's qualification using a document that verifies the welder has used the process at least every six months.</p>

**Example 1.1.1.** Table 1.1 illustrates a basic path that a Code user may follow to meet the requirements of Section IX. These steps are the basic concept of a video prepared for the State of Wisconsin titled *Before You Strike an Arc*. The State of Wisconsin required all contractors to review this video before starting construction, which requires Section IX qualifications.

The authors cannot overemphasize the importance of keeping in mind the document that is being addressed. Most mistakes are made when the Code user is working with one of the three documents, while applying a requirement from one of the other documents.

The ASME Code writing committees would do a great service to industry if they would produce three separate Codes:

- The first for the “preparation” of the welding procedure specification (WPS),
- The second for the “qualification” of the WPS and the documentation of that qualification on a Procedure Qualification Record (PQR),
- The third for the “qualification” of the welder’s performance and the documentation of that qualification on a Welders Performance Qualification (WPQ) record.

These three documents, however, are intermixed within Section IX. The Code user must know which of these three documents is being considered at all times. Mixing of the rules for one document with another is the biggest source of confusion when using Section IX.

Another source of confusion is the common use of the word, “procedure.” When someone refers to “the procedure,” or “welding procedure,” it is not certain if they are referring to the welding procedure specification (WPS) or the procedure qualification record (PQR). The Code user may avoid this source of confusion if the proper terms are always used.

**Special Note:** Standard Welding Procedure Specifications (SWPS) are covered in Article V of Section IX and are described in Chapter 15 of this guide. SWPSs have been recently added to Section IX and are handled by separate rules of Chapter 15 and Section IX.

## Forward

The Code user should be aware of the Foreword in each of the ASME Code Sections. The Foreword explains that one of the functions of the Boiler and Pressure Vessel Committee is to interpret the rules of the Code when questions arise regarding their intent. The Foreword further states “only the Boiler and Pressure Vessel Committee has the authority to provide official interpretations of this Code”. This guide is not intended to provide, and does not portray any of the statements herein to be an official interpretation of the Code. CAUTION: The reader is advised that guidance should be obtained from the Jurisdictional Authority where the welding is to be performed or registered.

Anyone may make a formal inquiry to the ASME Code Committees, following the rules in the mandatory appendix for each code. The Code committees review all inquiries and prepare the official replies of the ASME Boiler and Pressure Vessel Committee following formal committee rules. This guide uses frequent references to these official Interpretations of the ASME Boiler and Pressure Vessel Code Committees. When referenced, the ASME Interpretations will be contained in square brackets [].

## Interpretations

The ASME Boiler and Pressure Vessel Committee publish Interpretations twice a year. The first eleven volumes were each issued by ASME with Interpretations for Sections I through XI contained in a single booklet. Volume 1 covered replies dated January 1, 1977 through June 30, 1977. Volumes 1 through 5 were published in white covers, while volumes 6 through 11 were published in green covers.

Beginning with volume 12, the Interpretations were issued separately for each code section, loose leaf printed. ASME numbered these individual code section Interpretations beginning with volume 12 as page number 1. Each issue of interpretations contains a complete numerical index and subject index for all volumes. These indices also reference the page on which the Interpretation may be found, beginning with volume 12. The first eleven volumes are not included in these indices. When this guide refers to an ASME Interpretation from volume 12 or higher, only the interpretation number is given. When this guide refers to an Interpretation prior to volume 12, the volume number is also included for quick reference. Each of the interpretations referred in this guide have been reproduced in Appendix 4. There is an ASME Interpretation Index for those interpretations used in this guide.

Chapter 14 makes reference to [Interpretations IX-80-04, IX-80-10, IX-89-100 and IX-92-87]. This guide has additional information on each of these Interpretations to explain how editorial corrections, revisions, rearrangement of paragraphs, and what ASME does if duplicate interpretations are issued.

The cover sheet which comes with these interpretations states “Interpretations are not part of the Code or the Addenda”. While this is true, this guide has used liberal references to these Interpretations as the best method of helping the Code user to understand the *intent* of the ASME Boiler and Pressure Vessel Committees.

The following is a brief description of the Interpretation designation system, using IX-83-172 as an example. This Interpretation applies to the documentation of the use of a consumable insert as required by QW-404.22 for the GTAW process, and the weld pass thickness as required by QW-403.9 for the SMAW process, on both the WPS and PQR. The identification is applied as follows:

- IX indicates that the Interpretation relates to ASME Section IX.
- -83 indicates the year of the Code Edition to which the response was made.
- -172 indicates that this Interpretation was the 172<sup>nd</sup> Interpretation published against the 1983 Edition of ASME Section IX

## Revisions

The foreword of Section IX also notes that after ASME approves Code revisions, the revisions may be used beginning with the date of issuance. Revisions become mandatory 6 months after such date of issuance. This guide is based upon the July 1, 2001 Edition of Section IX. The Code user should be aware that ASME publishes annual addenda, which may change the structure and the rules of Section IX, and possibly affect some of the information in this guide.

## SI Units

The 2001 Edition of the ASME Boiler & Pressure Vessel Code contains both U. S. Customary and SI Units. When used, the measurements are made first using the US Customary system, followed by the SI Units in parenthesis. In all cases, the U.S. Customary units are the standard and the SI units are provided for the convenience of the Code user.

The U. S. Customary numbers and the SI Unit numbers are presented without dimensions in some of the Section IX tables. For example, in QW-451.1, an entry may be shown in a column as  $\frac{3}{4}$  (19) to less than  $1\frac{1}{2}$  (38). However, the notation in the header of the column in QW451.1 indicates; “Thickness of Test Coupon Welded, in. (mm).”

There are some major tables, for example QW/QB-422, which uses only the U.S. Customary system for the Minimum Specified Tensile, ksi, column, but uses the dual unit system under Product Form; Plate > 2 in. (51mm). **Note:** Section IX generally uses the abbreviation; “in.” rather than “inch.”

There are some cases where the conversion factors differ, when the value is changed from fractions to decimals. For example, the designation for  $1\frac{1}{2}$  inch (38 mm) is reported in another location as 1.50 inch (38.1mm).

There are numerous areas in Section IX, which use the dual system, and the U.S. Customary units are the only dimensions used.

There are some examples used in this guide, which will not work precisely with the dual system without compromise. For example, Section IX lists  $\frac{1}{2}$  inch (13 mm); and 1 inch (25 mm). These are “very soft” conversions. For example, a production application thickness of 1 inch (25 mm) requires a test coupon of  $\frac{1}{2}$  inch (13 mm). Or should it be a test coupon of  $\frac{1}{2}$  inch (12.5 mm)? Or should it be a test coupon of 12.7 mm? This guide suggests the Code user take the most conservative approach, which, in this example, would be to use a 13 mm test coupon, or the “hard” conversion of 12.7 mm. The adoption of the dual dimension system may well be the cause of a large number of inquiries to the ASME Code Committees.

No one can predict the future direction of Section IX. This Guide, however, has been prepared on the basis that the use of both U.S. Customary and SI Units will continue to be used in Section IX. This Guide will attempt to use both the U.S. Customary and SI Units in this Guide wherever possible. The space in some of the tables is quite restricted, in which case; this Guide will use only the US Standard system. There are some examples wherein this Guide will use the exact dimensions, as published in Section IX, so the Code user can more easily follow Section IX with this Guide.

**Note:** See the table titled *Commonly Used Conversion Factors* (from 2001 Edition of ASME Section IX) in Appendix 2 of this Guide. See also the table titled *Conversion of U.S. Customary Units to SI Units as Used in the CASTI Guidebook to ASME Section IX – Welding Qualifications* in Appendix 2.

## Purpose

This guide is intended to be an instructive reference to help Section IX Code users understand how to meet the minimum requirements of the Code and to provide insight on the intent of the Code regarding the qualification of welders and welding procedure specifications. This guide also provides examples of how to meet these Code requirements along with checklists to assist in assessing if Code requirements have been met.

Finally, this guide provides a means to verify that welding documentation is in full accord with the minimum requirements of the Code. As active participants in the development and maintenance of the Code, the authors provide valuable insights into the nuances of the Code and how it has evolved into its current form. However, following this guide or the Code itself cannot ensure that welding procedure specifications or welders are capable of producing welds that will meet the specific requirements of any product for the intended service life of the product.

This guide has been prepared to assist Code users in understanding and interpreting the ASME Section IX. This guide, however, does not replace Section IX. This guide is not intended to assist in the proper selection of processes, welding procedure specifications, joint design, filler metal, preheat, post weld treatment, or other variables. Nor is it intended to assist the Code user in making better welds or in verifying that a welding procedure specification is acceptable for any specific application.

The Foreword states that the Code does not address all activities of Code construction. “The Code is not a handbook and cannot replace education, experience, and the use of engineering judgment” by knowledgeable designers experienced in the application of the Code. This guide may be helpful, but requires sound input from welding, metallurgical, process, and design engineers in concert with welders and inspectors who understand and appreciate the intent of the Boiler and Pressure Vessel Code. The application, service, and life of the item must be carefully engineered. Code users should provide proper techniques, training, and education for all personnel.

This guide contains information about Code paragraphs, variables, figures, tables, and graphics, as well as information from other codes and standards (ASTM, AWS, etc.) for discussion herein. It also contains many examples that integrate pertinent references in one place, in a logical manner, to clarify and provide continuity to a specific topic. This does not imply that the Code follows this same sequence, and neither does it imply that the Code is deficient by not following this format. Code paragraphs referenced in this guide may contain additional comments, paraphrasing, explanations, clarifications, interpretations, or opinions. Also some Code paragraphs have been restated in this guide, because they are very important and are difficult to review merely by reference to Section IX. In each case, Section IX and the appropriate construction codes must be available for referral when using this guide so the tables, charts, figures, examples and comments in the guide can be compared to the current code requirements. The current codes must be used for actual qualifications, testing, documentation, etc. At no time may any portion of this guide be used in place of the Code, this guide is intended to be used in concert with the Code.

This guide normally makes references without notation of the chapter where the reference is located. It is not necessary to note which chapter the reference is from because the first number in the reference is the number of the chapter where the table, figure, or example is located.

## **Tables and Figures**

Tables and figures are sequentially numbered beginning with the number of the chapter. For example, Table 1.1 is the first table in chapter 1. Figure 2.1 is the first figure in chapter 2. Examples are usually associated with a table, and are sequentially numbered beginning with the table number. For instance, Example 4.3.1 is the first example in Table 4.3 found in chapter 4. Other examples may simply be a stated example, contained within the paragraph being covered. Figures may appear within a table, e.g. Example 4.16.1 references Figure 4.10 in Table 4.16.

## **ASME Numbering System**

This guide references the ASME code sections using the ASME identification system. For example, for Section IX, ASME uses “Q” as the leading identifier for all paragraphs, tables, charts, etc. The Q represents the scope of ASME Section IX, which is the “qualification” of welders and the “qualification” of welding procedure specifications for code construction. For Section VIII, ASME uses “U” as the leading identifier for “unfired” pressure vessels. For the purposes of this guide, the word *Code* with a capital “C” refers to ASME Section IX, while the word *code* with a lower case “c” refers to a code other than Section IX. ASME Section IX is a service Code, in that it is referenced by ASME construction codes and other international codes and standards.

# Chapter 2

## **WELDING DOCUMENTATION FORMS**

This chapter discusses the documentation and application of the welding forms found in Nonmandatory Appendix B of ASME Section IX.

The scope of ASME Section IX is the qualification of welders and the welding procedure specifications they employ in welding according to the ASME Boiler and Pressure Vessel Code and the ASME B31 codes for pressure piping. This guide covers four documents, specifically,

- QW-482, Format for the the Welding Procedure Specification (WPS) (Figure 2.1),
- QW-483, Format for the Procedure Qualification Record (PQR) (Figure 2.2),
- QW-484, Format A for the Welder Performance Qualification Record (WPQ) (Figure 2.3),
- QW-485, Format for the Demonstration Test Record (DTR) (Figure 2.5).

The rules that apply to these three documents cover the majority of the requirements of Section IX. This chapter is intended to familiarize the Code user with the Code requirements for recording or specifying details for the WPS, QW-482, the PQR, QW-483 and the WPQ, QW-484.

QW-484, Format B, a Welding Operator Performance Qualifications (WOPQ) form is shown in Figure 2.4. The rules for Welding Operators are discussed in Chapter 13.

QW-485, a Demonstration Test Record of Standard Welding Procedure Specifications (DTR) form is shown in (Figure 2.5). The rules for Standard Welding Procedure Specifications (SWPS) are discussed in Chapter 15.

The following Code paragraphs (paraphrased and edited) define what is required to be included in the WPS, PQR & WPQ.

### **Welding Procedure Specification (WPS)**

- QW-200.1 Each manufacturer (Code user) shall prepare written WPSs (Figure 2.1).
- QW-200.1(a) A WPS is a written, qualified, document prepared to provide direction for making production welds to code requirements.
- QW-200.1(b) The completed WPS shall describe all of the essential, nonessential, and, when required, supplementary essential variables for each process used in the WPS. The WPS shall reference the supporting Procedure Qualification Record(s) PQR.
- QW-200.1 c) Changes may be made in the nonessential variables, without requalification, provided the changes are documented by revision or amendment or by use of a new WPS. Changes in essential or supplementary essential (when required) variables require requalification of the WPS.

QW-200.1(d) The information required to be in a WPS may be in any format as long as every essential, nonessential, and, when required, supplementary essential variable outlined in QW-250 through QW-280 (Table 6.1 QW-253 for SMAW) is included or referenced.

### **Procedure Qualification Record (PQR)**

QW-200.2 Each manufacturer shall prepare a PQR (Figure 2.2).

QW-103.2 Each manufacturer shall maintain a record of the results obtained in welding procedure qualifications. This paragraph is intended to require Code users to record on a PQR, the results of the procedure qualification tests.

QW-200.2(a) A PQR is a record of the welding variables and other welding data used to weld a test coupon, the tests used, and the test results.

QW-200.2(b) The completed PQR shall document all essential and, when required, supplementary essential variables for each process used. Other variables and information may be recorded at the Code user's option. [Interpretations IX 89-73 and IX 92-81 explain some of the Code users responsibility for these qualification requirements.]

QW-200.2(c) Changes to the PQR are not permitted, except editorial corrections or an addendum to reflect Code changes. If substantiated as having been part of the original qualification by laboratory record or similar data, additional information may be added to the PQR.

QW-200.2(d) The information required to be in a PQR may be in any format provided every essential and, when required, supplementary essential variable, specified by QW-250 through QW-280 (Table 3.3, QW-253 for SMAW) is included. The type, number, and results of the tests shall also be recorded in the PQR.

### **Welders Performance Qualification (WPQ)**

QW-103.2 Each Code user shall maintain a record of the results obtained in welder performance qualifications. This paragraph is intended to require Code users to record the results of the performance qualification test on a WPQ (Figure 2.3) or WOPQ (Figure 2.4) record.

QW-301.2 Each Code user shall qualify each welder for each welding process to be used in production welding. The performance qualification test shall be welded in accordance with a qualified WPS. Changes beyond which requalification is required are given in QW-351 through QW-357 for welders. Visual, mechanical, and radiographic examination are described in QW-304 for welders.

QW-301.4 The record of WPQ tests shall include the essential variables (Table 10.1, QW-353 for SMAW), the type of tests, the test results and the ranges qualified for each welder.

### **Standard Welding Procedure Specifications (SWPS)**

QW-100.1 A manufacturer may use an AWS Standard Welding Procedure Specification (SWPS) listed in Appendix E, provided the SWPS has been adopted by that manufacturer in accordance with Article V.

QW-510(d) The manufacturer shall weld and test one groove weld demonstration test coupon following that SWPS.

**QW-482 SUGGESTED FORMAT FOR WELDING PROCEDURE SPECIFICATIONS (WPS)**  
 (See QW-200.1, Section IX, ASME Boiler and Pressure Vessel Code)

Company Name \_\_\_\_\_ By: \_\_\_\_\_  
 Welding Procedure Specification No. \_\_\_\_\_ Date \_\_\_\_\_ Supporting PQR No.(s) \_\_\_\_\_  
 Revision No. \_\_\_\_\_ Date \_\_\_\_\_

Welding Process(es) \_\_\_\_\_ Type(s) \_\_\_\_\_  
 (Automatic, Manual, Machine, or Semi-Auto)

**JOINTS (QW-402) Details**

Joint Design \_\_\_\_\_  
 Backing (Yes) \_\_\_\_\_ (No) \_\_\_\_\_  
 Backing Material (Type) \_\_\_\_\_  
 (Refer to both backing and retainers.)

Metal       Nonfusing Metal  
 Nonmetallic       Other

Sketches, Production Drawings, Weld Symbols or Written Description should show the general arrangement of the parts to be welded. Where applicable, the root spacing and the details of weld groove may be specified.

(At the option of the Mfr., sketches may be attached to illustrate joint design, weld layers and bead sequence, e.g., for notch toughness procedures, for multiple process procedures, etc.)

---

**\*BASE METALS (QW-403)**

P-No. \_\_\_\_\_ Group No. \_\_\_\_\_ to P-No. \_\_\_\_\_ Group No. \_\_\_\_\_  
 OR  
 Specification type and grade \_\_\_\_\_  
 to Specification type and grade \_\_\_\_\_  
 OR  
 Chem. Analysis and Mech. Prop. \_\_\_\_\_  
 to Chem. Analysis and Mech. Prop. \_\_\_\_\_  
 Thickness Range:  
 Base Metal: Groove \_\_\_\_\_ Fillet \_\_\_\_\_  
 Other \_\_\_\_\_

---

**\*FILLER METALS (QW-404)**

Spec. No. (SFA) _____	_____	_____
AWS No. (Class) _____	_____	_____
F-No. _____	_____	_____
A-No. _____	_____	_____
Size of Filler Metals _____	_____	_____
Weld Metal		
Thickness Range:		
Groove _____	_____	_____
Fillet _____	_____	_____
Electrode-Flux (Class) _____	_____	_____
Flux Trade Name _____	_____	_____
Consumable Insert _____	_____	_____
Other _____	_____	_____

\*Each base metal-filler metal combination should be recorded individually.

Figure 2.1 QW-482 Form - Nonmandatory Appendix B (Page 1 of 2)



QW-482 (Back)																							
						WPS No. _____	Rev. _____																
<b>POSITIONS (QW-405)</b> Position(s) of Groove _____ Welding Progression: Up _____ Down _____ Position(s) of Fillet _____				<b>POSTWELD HEAT TREATMENT (QW-407)</b> Temperature Range _____ Time Range _____																			
<b>PREHEAT (QW-406)</b> Preheat Temp. Min. _____ Interpass Temp. Max. _____ Preheat Maintenance _____ <small>(Continuous or special heating where applicable should be recorded)</small>				<b>GAS (QW-408)</b> <table style="width:100%; border-collapse: collapse;"> <thead> <tr> <th style="width: 30%;"></th> <th style="width: 20%;">Gas(es)</th> <th style="width: 30%;">Percent Composition (Mixture)</th> <th style="width: 20%;">Flow Rate</th> </tr> </thead> <tbody> <tr> <td>Shielding</td> <td>_____</td> <td>_____</td> <td>_____</td> </tr> <tr> <td>Trailing</td> <td>_____</td> <td>_____</td> <td>_____</td> </tr> <tr> <td>Backing</td> <td>_____</td> <td>_____</td> <td>_____</td> </tr> </tbody> </table>					Gas(es)	Percent Composition (Mixture)	Flow Rate	Shielding	_____	_____	_____	Trailing	_____	_____	_____	Backing	_____	_____	_____
	Gas(es)	Percent Composition (Mixture)	Flow Rate																				
Shielding	_____	_____	_____																				
Trailing	_____	_____	_____																				
Backing	_____	_____	_____																				
<b>ELECTRICAL CHARACTERISTICS (QW-409)</b> Current AC or DC _____ Polarity _____ Amps (Range) _____ Volts (Range) _____ <small>(Amps and volts range should be recorded for each electrode size, position, and thickness, etc. This information may be listed in a tabular form similar to that shown below.)</small>  Tungsten Electrode Size and Type _____ <span style="margin-left: 350px;">(Pure Tungsten, 2% Thoriated, etc.)</span> Mode of Metal Transfer for GMAW _____ <span style="margin-left: 350px;">(Spray arc, short circuiting arc, etc.)</span> Electrode Wire Feed Speed Range _____																							
<b>TECHNIQUE (QW-410)</b> String or Weave Bead _____ Orifice or Gas Cup Size _____ Initial and Interpass Cleaning (Brushing, Grinding, etc.) _____  Method of Back Gouging _____ Oscillation _____ Contact Tube to work Distance _____ Multiple or Single Pass (per side) _____ Multiple or single Electrodes _____ Travel speed (Range) _____ Peening _____ Other _____ _____ _____																							
Weld Layer(s)	Process	Filler Metal		Current		Volt Range	Travel Speed Range	Other (e.g., Remarks, Comments, Hot Wire Addition, Technique, Torch Angle, Etc.)															
		Class	Dia.	Type Polar.	Amp. Range																		

Figure 2.1 QW-482 Form - Nonmandatory Appendix B (Page 2 of 2)

# Chapter 3

## **REVIEW OF ARTICLE I – GENERAL, ARTICLE II – PROCEDURE, AND ARTICLE III – PERFORMANCE,**

This Chapter provides the Code user with an outline of the first three Articles of Section IX.

Section IX is divided into two parts,

- Part QW Welding
- Part QB Brazing.

Part QW Welding, is divided into five articles,

- Article I – General,
- Article II – Procedure,
- Article III – Performance,
- Article IV – Welding Data,
- Article V – Standard Welding Procedure Specifications.

This chapter outlines the material covered in Part QW, Article I, Article II and Article III of Section IX.

Code users seldom refer to these sections as Articles. They are more likely to refer to the “one hundred section” (QW-100) for general items, the “two hundred section” (QW-200) for items relating to WPS and PQR preparation, the “three hundred section” (QW-300) for items relating to welder’s performance qualification, and the “five hundred section” (QW-500) for items relating to Standard Welding Procedure Specifications.

### **Article I - General**

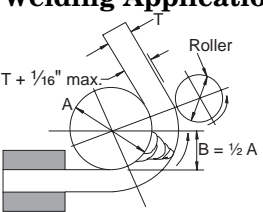
Table 3.1 provides a convenient outline of Article I showing how each paragraph relates to the welding application, the WPS, the PQR and the WPQ. Each article opens with a General section that defines the scope of the article, as in QW-100 General.

QW-100.1 defines; “the purpose of the WPS and PQR is to determine that the weldment proposed for construction is capable of providing the required properties for its intended application.” This terse opening statement puts the responsibility on the Code user to assure that welding qualifications are suitable for the welding application.

**Note:** Section IX does not cover the application, service, or life of the component.

QW-100.1 and QW-100.2 provide definitions of the three documents: the WPS, the PQR, and the WPQ.

Table 3.1 Summary of Article I - Welding General Requirements

<b>Welding Application</b>  Figure 3.1	<b>WPS</b>  Specify:  Variable ranges Essential variables Nonessential variables Other directions	<b>PQR</b>  Record:  Actual values Essential variables Tests and results Other data	<b>WPQ</b>  Record:      Specify: value          range tested          qualified  Record tests and results		
QW-100 General - Section IX relates to the qualification of welders and the procedures (WPS) they use according to ASME Codes. (QW-100 applies to all four columns)					
	QW-100.1 Relates to the purpose of WPS.	QW-100.1 Relates to the purpose of PQR.	QW-100.2 Relates to the purpose of WPQ.		
	QW-100.3 Documents meeting the requirements of the 1962 or later editions may be used in any construction built to the ASME Codes. <b>Caution:</b> The construction codes may have restrictions.				
QW-103.1 Manufacturer responsible.	QW-103.1 The Manufacturer shall qualify the WPS.	QW-103 Manufacturer shall conduct tests and maintain PQR and WPQ records.			
QW-110 Weld position QW-461.1.		QW-120 Test position, QW-461.3.			
		QW-140 Types and purposes of tests and examinations.			
		QW-150 Tensile test specimens, procedure, acceptance.	QW-142 RT radiography.  QW-144 VT visual.		
		QW-160 Bend test (ductility) Figure 3.1	QW-160 Bend test (soundness) Figure 3.1		
		QW-161 Face, root, side bends; QW-162 Procedure; QW-163 Acceptance.			
		QW-170 Notch-toughness tests.			
		QW-181.1 Fillet weld tests PQR.	QW-181.2 Fillet weld tests WPQ.		
				QW-194 Visual examination.	
				QW-191 Radiography.	
		QW-195 Liquid penetrant examination (CRWMO) PQR and WPQ.		QW-196 Resistance weld testing (equipment & operator).	

**Note:** This table lists the paragraphs that apply, directly below the production application or below the welding document(s), the WPS, PQR or WPQ to which they apply. This system is used throughout the Guide.

QW-100.3 covers the WPS, PQR, and WPQ, in more detail. QW-100.3 states that these documents, prepared in accordance with Section IX, may be used in any ASME construction. The second paragraph states that other Sections of the code may have additional requirements, and may provide exemptions from the rules of Section IX. An example of an additional requirement would be when ASME Section VIII, Division 1 requires impact testing. UG-84(h)(2)(b) requires a change in heat treat condition of the base plate to be handled as an additional supplementary essential variable. An example of an exemption to Section IX would be when, subject to the approval of the owner, ASME B31.1 allows procedures and welders to be qualified by a technically qualified group, under specific conditions, as an exemption to the requirements of QW-201 and QW-300.2.

QW-100.3 also allows the continued use of a WPS, PQR or WPQ, qualified at any time in the past, provided all requirements of the 1962 or later Edition are met. [Interpretations IX-79-30, volume 5, IX-81-45, volume 10 and IX-92-71 are excellent references for the liberal application of these rules]. QW-100.3 does not require a WPS, WPQ or a PQR to be amended to include any variables required by later Editions and Addenda. An example would be the variable QW-403.16, a change in the pipe diameter beyond the range qualified in QW-452, which was added in the 1969 addenda. QW-100.3 allows a welder, qualified in 1962, to continue welding, without additional testing, and without an amendment to the welders WPQ, when QW-403.16 was added in the 1969 addenda. However, it is recommended that Code users react to the addition of such a meaningful variable. Code users should requalify the welder using the new variable QW-403.16 in the performance qualification test.

QW-100.3 does, however, require the qualification of a new WPS or WPQ, or, the requalification of an existing WPS or WPQ to be performed in full accordance with the latest Edition and Addenda of Section IX. For example, a welder qualified in 1962, would have no requirement to be requalified as a result of the 1969 addition of QW-403.16, provided the welder continuously welded using the process. However, if in 1995, the welder lost his qualification because there was a specific reason to question his ability, the welder would have to be requalified using the current Edition and Addenda of the Code, including the new variable of QW-403.16. Another example is: [Interpretation IX-92-71 makes it clear that welders qualified prior to the 1992 addenda do not have to requalify to document their visual examination results.]

**Caution:** It is recommended that the Code user review each Edition and Addenda of the Code as they are issued. Code users should address all technically sound new requirements. Code users should consider requalification of PQRs and WPQs as variables are revised or added, although Section IX does not require this.

QW-103.1 requires the Code user to conduct the tests used to qualify the welding procedures and welders for welding under this Code. [Interpretations IX-92-09 and IX-92-16 make it clear that this requirement may not be subcontracted.]

QW-110 covers the weld orientation. It is important to recognize that there are test positions, as described in QW-120, and there are welding application positions. See Chapter 4 for a detailed explanation. The test positions in QW-120 and QW-461.3 through 461.8 define a narrow range of positions that are allowed as one of the test positions. The test positions are labeled, for example, as 1G, 2G, 3G, etc. and 1F, 2F, 3F, etc. (see Figures 4.14 and 4.15)

The welding application positions are determined in accordance with QW-461.1 (Figure 4.16) for groove welds and QW-461.2 for fillet welds within the ranges specified in QW-461.9 (Table 4.23). These application positions have a much wider range of latitude. For example, the vertical limitation of a 3G test plate, according to QW-120, is  $\pm 15^\circ$ , while the vertical limitation of a vertical plate welding application may be as much as  $75^\circ$  from vertical as shown in QW-461.1 (Figure 4.16). Make certain you

The following list briefly describes the performance qualification variables for the SMAW process, in the order shown in Table 3.5 (QW-353).

- QW-402.4 The deletion of the backing in single welded groove welds. Double welded groove welds are considered welding with backing. **Note:** The addition of backing is not a variable. Therefore a welder that qualifies without backing is also qualified to weld with backing.
- QW-403.16 A change in the pipe diameter beyond the range qualified in QW-452. Welding small diameter pipe is the main concern here.
- QW-403.18 A change in P-Numbers, except as permitted in QW-420.2 and QW-423. While P-number is a variable, section IX allows the welder to be qualified on many different P-numbers simply by welding with one P-number.
- QW-404.15 A change in F-Numbers of QW-432, except as permitted in QW-433. F-numbers are critical and usually the welder receives qualification for the F-number used during the testing.
- QW-404.30 A change in weld metal thickness beyond the range qualified in QW-452. Weld metal thickness is the only thickness limitation imposed on a welder. Base metal thickness is not a variable.
- QW-405.1 The addition of positions other than those already qualified. Proving the ability to weld in all necessary positions is critical for a welder.
- QW-405.3 A change in the progression of a vertical weld (3G, 5G, 6G, 3F test positions). Read this variable carefully so that the welder can be qualified with the least number of restrictions.

Each of these variables are covered in detail in chapter 10.

# Chapter 4

## **REVIEW OF ARTICLE IV – WELDING DATA**

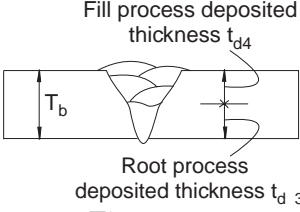
This Chapter provides an overview of ASME Section IX Article IV, Welding Data. Article IV, is commonly referred to as the 400 section. The QW-400 paragraphs define variables, P-Numbers, S-Numbers, F-Numbers, A-Numbers, the type and number of tests, the weld metal and base metal thickness ranges, pipe diameter ranges, welding positions, test positions, welding progression, dimensions of test specimens, order of removal of test specimens, dimensions of test jigs, test rules for all materials, etching processes and reagents, and definitions.

This chapter is intended to explain each type of welding data in the order that they are found in Article IV. Tables, figures and charts are used with examples to explain the purpose of each welding variable. Most examples concentrate on one variable at a time. In every case the Code user must remember that all other variables and details must be considered when evaluating a single change. This detailed explanation of each variable is intended to provide the Code user with a base for evaluating the WPS, PQR and WPQ documentation requirements.

Table 4.1 outlines all the items within Article IV. This table shows the pattern of where each of the paragraphs apply with respect to the Welding Application, WPS, PQR or WPQ. This may help the Code user when considering a given variable. The following bulleted illustration and Table 4.1 illustrate how each paragraph applies quite differently as shown:

- QW-401.1 describes the essential variables which apply to both the **WPS and the PQR**.
- QW-401.2 describes the essential variables which apply only to the **WPQ**.
- QW-401.4 describes the nonessential variables which apply only to the **WPS**.
- QW-402 through QW-410 describe the variables which may apply to the **WPS, PQR or WPQ, depending on the welding process**.
- QW-420 explains base metal groupings and assigns base metals to **P-Numbers, Group numbers, and S-Numbers**.
- QW-430 defines filler material grouping in **F-Numbers**.
- QW-440 defines filler metal assignment by type of deposit as **A-Numbers**.
- QW-450 specifies type and number of tests to be performed for the **PQR and WPQ**.
- QW-461.1 defines groove welding positions which apply to the **Application and the WPS**.
- QW-461.4 illustrates groove welded test positions, which apply to the **PQR and WPQ**.
- QW-461.9 illustrates the position and diameter limitations for **WPQ**.
- QW-470 defines etching processes and reagents for various materials.
- QW-492 contains definitions, which apply to the **Application and the WPS, PQR and WPQ**.

Table 4.1 Article IV - Welding Data

<p><b>Welding Application</b></p>  <p>Fill process deposited thickness <math>t_{d4}</math></p> <p>Root process deposited thickness <math>t_{d3}</math></p> <p>Figure 4.1</p>	<p><b>WPS</b></p> <p>Specify:</p> <p>Variable ranges</p> <p>Essential variables</p> <p>Nonessential variables</p> <p>Other directions</p>	<p><b>PQR</b></p> <p>Record:</p> <p>Actual values</p> <p>Essential variables</p> <p>Tests and results</p> <p>Other data</p>	<p><b>WPQ</b></p> <p>Record: Specify:</p> <p>value range</p> <p>tested qualified</p> <p>Record tests and results</p>
<p>QW-401 General Description of variables.</p>			
<p>QW-401.1 Defines essential variables for WPS &amp; PQR.</p>		<p>QW-401.2 Defines essential variables for WPQ.</p>	
<p>QW-401.3 Defines supplementary essential variables for WPS &amp; PQR.</p>			
<p>QW-401.4 Defines nonessential variables for WPS.</p>			
<p>QW-402 through QW-410 Variables, when referenced, may be Essential, Supplementary-Essential or Nonessential for WPS, PQR or WPQ.</p>			
<p>QW-420.1 Defines P-Nos. &amp; QW-420.2 defines S-Nos. This section also defines Group Nos. for notch-toughness.</p>			
<p>QW/QB-422 Lists P-Nos., Group Nos., and S-Nos. by specification, type, grade, UNS No. min. tensile strength, composition &amp; product form.</p>			
<p>QW-431 Defines F-Numbers and rules for grouping filler metals. QW-432 Lists F-Numbers by types of steels, copper, nickel, etc., with ASME Specification &amp; AWS Classification.</p>			
<p>QW-441 Identification of ferrous weld metal A-Number analysis as given in QW-404.5. QW-442 Lists A-Numbers by type of deposit.</p>			
<p>QW-451 Lists type &amp; number of tests &amp; ranges of base and weld metal thickness.</p>		<p>QW-452 type &amp; number of tests, &amp; range of weld metal thickness.</p>	
<p>QW-461.1 Defines welding positions as described on the WPS and for production applications as flat (F), horizontal (H), vertical (V), overhead (OH).</p>	<p>QW-461.3 through QW-461.8 shows Test positions as 2G, 3F, and etc.</p>		<p>QW-461.9 Lists the type of weld, the test position used and the position and diameter limits.</p>
		<p>QW-462 Illustrates dimensions and limitations of test specimens.</p>	
		<p>QW-463 Illustrates order of removal of test specimens taken from test coupons.</p>	
		<p>QW-466 Illustrates dimensions of test jigs and rules for each type of material.</p>	
		<p>QW-470 Defines etching processes and reagents for various materials.</p>	
<p>QW-492 Covers definitions which apply to welding applications. They are a very useful reference for Section IX. These definitions may vary slightly from AWS definitions.</p>			

## Variables

The first item in Article IV is the welding variables. Welding variables may apply to one, two or all three documents (WPS, PQR and WPQ). Welding variables are required only when referenced, by process, in QW-250 for the WPS, in QW-250 for the PQR or in QW-350 for the WPQ. Welding variables may be essential, nonessential and supplementary essential variables. Figure 4.2 (Table 4.2) illustrates a sample application listing typical entries for each group of variables. Table 4.2 outlines how each of the three types of variables apply to the WPS, PQR and WPQ.

The following lists four common variables. The Code user must first determine where each of these variables apply. QW-250 lists the variables for the preparation of the WPS, PQR. QW-350 lists the variables for the preparation of the WPQ. The following illustrates how different variables may apply to one or more of the three welding documents, the WPS, PQR and WPQ.

- **Backing (QW-402.4)**

QW-253 references QW-402.4, backing, FOR the WPS but NOT FOR the PQR.  
QW-353 references QW-402.4, backing, FOR the WPQ.

- **Base Metal Thickness ( $T_b$ ) (QW-403.8)**

QW-253 (Table 3.3) references QW-403.8, (base metal thickness) ( $T_b$ ) FOR the WPS and PQR.  
QW-353 (Table 3.5) DOES NOT reference QW-403.8, (base metal thickness) ( $T_b$ ) for the WPQ.

- **Pipe Diameter QW-403.16**

QW-253 DOES NOT reference pipe diameter for either the WPS or the PQR.  
QW-353 references QW-403.16, (pipe diameter) FOR the WPQ.

- **Weld metal Thickness ( $t_d$ )**

QW-253 references QW-404.30, (the weld metal thickness) ( $t_d$ ) for both the WPS and the PQR.  
QW-353 references QW-404.30, (the weld metal thickness) ( $t_d$ ) for the WPQ.

Table 4.3, Figure 4.3 illustrates another simple change in four variables, and how the change affects each of the three documents, the WPS, PQR and WPQ.

**Example 4.3.1** The change in the groove design affects only the WPS.

**Example 4.3.2** The change in the F-Number affects the WPS, PQR and the WPQ.

**Example 4.3.3** The change in backing affects only the WPS and the WPQ.

**Example 4.3.4** The change in product form from plate to pipe affects only the WPQ.

These are good illustrations of the need to identify the variables required for each document.

- QW-250 lists the essential and nonessential variables, by process, which must be specified on the WPS.
- QW-250 lists the essential variables, by process, which must be recorded on the PQR.
- QW-350 lists the essential variables, by process, which must be recorded on, and the qualified ranges specified on, the WPQ.



**Special Note:** Variables are seldom written as complete sentences. Subcommittee IX developed the rules for the preparation of a WPS and the qualification test to be recorded on a PQR using committee member company documents as a model. For example, the committee agreed that a change in the “Type of Joint” was a proper variable, based on their typical company WPS. Since the member’s company documents each had a joint type on their WPS, they agreed that the variable should state: QW-402.1 “A change in the type of groove.” This is not a complete sentence, but it reflects the committee thinking at the time. These variables have changed over the years based upon inquiries from Code users. As a result, the committee later added the examples to QW-402.1 as: “(Vee-groove, U-groove, single-bevel, double-bevel, etc.). Think of variables as though you have your WPS, PQR or WPQ, and “a change, addition or deletion” will require a revision to the document. If the change is an essential variable, the WPS or WPQ will have to be requalified. If the change is a nonessential variable, the WPS will have to be revised.

## P-Numbers, Group Numbers and S-Numbers

### P-Numbers

Base metals are grouped into P-Numbers for the purpose of Qualification. The complete listing of P-Numbers is found in QW/QB-422. Note that base metals for welding and brazing are combined in this table. QW/QB-422 lists each of the base metals in a numeric sequence based upon the ASTM material specification number. When the ASME codes adopt an ASTM material specification, an A-XXX, ASME designates this acceptance by adding an S to the ASTM specification. The ASME material specification, Section II, Part A, for example, specifies all ASME adopted metals as SA-XXX. The SA marking indicates that the material has been produced in accordance with the ASME SA-XXX specification, which may be identical to the ASTM A-XXX specification, or there may be some exceptions.

QW/QB-422 is a convenient place to find the P-Number when the Code user knows which base metal is being used. Table 4.4 outlines P-Numbers, with examples of how to find a P-Number. Table 4.5 provides a sampling of QW/QB-422.

**Special Note:** Appendix D is a nonmandatory listing of P-Numbers, and lists each of the base metals in a numeric sequence based upon the P-Number. Appendix D is a convenient place to find all the base metals of a given P-Number in one table. Appendix D may be very useful when a Code user is looking for other base metals within a given P-Number for the purpose of qualification.

**Example 4.4.1** illustrates how to find the P-Number of an ASME SA-53 Type S, Grade B material, as outlined in Table 4.4. (Also see Table 4.5 which is a sampling of QW/QB442, which includes SA-53 Type S, Grade B material.)

- a) under Spec. No. read down to find: SA-53,
- b) from SA-53, read across under Type & Grade to find: Type S, Grade B,
- c) continue across under UNS No. to find: K03005,
- d) continue across under Min. Specified Tensile ksi to find: 60,
- e) continue across under Welding,
  - 1) under P-No. to find: 1
  - 2) under Group No. to find; 1
  - 3) under S-No. to find: ...
  - 4) under Group No. to find: ...
- f) continue across under Brazing,
  - 1) under P-No. to find: 101,
  - 2) under S-No. to find: ...

- g) continue across under Nominal Composition to find: C-Mn,
- h) continue across under Product Form to find: Seamless Pipe.

This search reveals that the ASME SA-53, Type S, Grade B is a P-Number 1, Group Number 1, carbon manganese, seamless pipe, with a UNS Number of K03005, with a minimum specified tensile strength of 60 ksi, with a P-Number for brazing of 101, with no S-Number/Group Numbers assigned.

Table 4.4 defines P-Numbers and example 4.4.1 describes how to find a P-Number.

Figure 4.4 (Table 4.4) illustrates a typical vessel, with a group of base metals in Example 4.4.2, and how each of the three documents addresses P-Numbers. Table 4.4 also illustrates how a P-Number is used in each of the three documents.

Table 4.4 QW-420.1 - P-Numbers

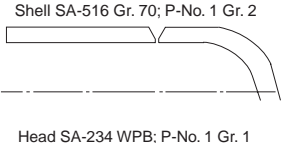
<p style="text-align: center;"><b>Welding Application</b></p>  <p style="text-align: center;">Figure 4.4</p>	<p style="text-align: center;"><b>WPS</b></p> <p>Specify:</p> <p>Variable ranges Essential variables Nonessential variables Other directions</p>	<p style="text-align: center;"><b>PQR</b></p> <p>Record:</p> <p>Actual values Essential variables Tests and results Other data</p>	<p style="text-align: center;"><b>WPQ</b></p> <p>Record:      Specify: value          range tested         qualified</p> <p>Record tests and results</p>
<p>QW-420 Families of base metals have been assigned a P-No. based on characteristics, composition, weldability, and other properties.</p>			
<p>How do you find a P-No.? QW/QB-422 lists all P-No. materials alpha-numerically by specification number.</p>			
<p><b>Example 4.4.1</b> Read down QW/QB-422 (Table 4.5 is a sampling of QW/QB-422) until you find your material by specification, type &amp; grade, then read across to determine the P-No. From QW/QB-422, find: SA-53 Type S, Gr. B and read across to find: UNS No. K03005, 60 ksi, P-No. 1 Gr. 1, (P-No 101 for brazing), C-Mn composition, Seamless Pipe.</p>			
<p>How do you use a P-No.?</p>	<p>QW-403.11 Base metals specified in the WPS shall be qualified by a procedure qualification test (PQR) made per QW-424.</p>		<p>QW-403.18 A change in a P-No. as permitted in QW-423.</p>
<p>When the base metal is P-No. 1</p>	<p>The WPS must specify P-No. 1.</p>	<p>PQR must weld a P-No. 1 test coupon.</p>	<p>WPQ must weld a P-No. 1 through 11 or P-No. 41 through 47.</p>
<p><b>Example 4.4.2</b> Base Metals: SA-106 Gr. B, P1 Gr.1 SA 105, P1 Gr. 2 SA-516 Gr. 70, P1 Gr. 2 SA-234 WPB P1 Gr. 1 A 192, P1 Gr. 1</p>	<p>Variable QW-403.11 requires the WPS to specify the P-No.'s which may be used with this WPS. In this case the WPS may list P-No. 1 base metals. (Plain carbon or mild steels). (Group numbers do not apply).</p>	<p>Variable QW-403.11 requires a PQR test coupon to be welded using a P-No. 1 base metal per QW-424 and recorded on the PQR. (Group numbers do not apply unless notch-toughness is invoked).</p>	<p>Variable QW-403.18 requires a welder to weld using any P-No. 1 through P-No. 11, P-No. 34, P-No. 41 through P-No. 47 per QW-423 &amp; recorded on the WPQ. (Group numbers are not a variable for the qualification of a welders performance).</p>

Table 4.5 is a brief sampling of base metals, typical of QW/QB-422 for Ferrous P-Numbers and S-Numbers. The P-Numbers are listed alpha-numerically.

Table 4.5 Sampling of QW/QB-422 - Ferrous P-Numbers and S-Numbers. Grouping of Base Metals for Qualification.

Spec. No.	Type & Grade	UNS No.	Minimum Specified Tensile ksi	Welding				Brazing		Nominal Comp.	Product Form
				P-No.	Group No.	S-No.	Group No.	P-No.	S-No.		
SA-36	...	K02600	58	1	1	...	...	...	...	C-Mn-Si	Plate, bar, ...
SA-53 <sup>a</sup>	Type E Gr. B	K03005	60	1	1	...	...	101	...	C-Mn	ERW Pipe
SA-53 <sup>a</sup>	Type S Gr. B	K03005	60	1	1	...	...	101	...	C-Mn	Smls Pipe
SA-105	...	K03504	70	1	2	...	...	101	...	C-Si	Flanges/fitting
SA-106	B	K03006	60	1	1	...	...	101	...	C-Si	Smls Pipe
A 108	1018 CW	G10180	60	...	...	1	1	...	101	C	Bar
A 134	A 285 B	K02200	50	...	...	1	1	..	101	C	Welded Pipe
SA-182 <sup>b</sup>	F11, Cl. 2	K11572	70	4	1	...	...	102	...	1¼ Cr-Mo	Forging
SA-182 <sup>b</sup>	F22, Cl. 1	K21590	60	5A	1	...	...	102	...	2¼ Cr-Mo	Forging
SA-182 <sup>b</sup>	F304L	S30403 <sup>c</sup>	70	8	1	...	...	102	...	18Cr-8Ni	Forging > 5 in.
A 211	A 570 Gr. 30	K02502	49	...	...	1	1	...	101	C	Welded Pipe
SA-234	WPB	K03006	60	1	1	...	...	101	...	C-Si	Piping Fitting
SA-234	WP5	K41545	60	5B	1	...	...	102	...	5Cr-½Mo	Piping Fitting
SA-240	Type 304L	S30403 <sup>c</sup>	70	8	1	...	...	102	...	18Cr-8Ni	Plate, sheet,
SA-335	P22	K21590	60	5A	1	...	...	102	...	2¼Cr-1Mo	Smls. Pipe
SA-387	11, Cl. 1	K11789	60	4	1	...	...	102	...	1¼Cr-½Mo	Plate
SA-516	Grade 60	K02100	60	1	1	...	...	101	...	C-Mn-Si	Plate
API5L	Grade B	...	60	...	...	1	1	...	101	C-Mn	Smls/welded

- a. Both SA-53 specifications have the same UNS Number, but they are different product forms.
- b. These SA-182 materials have the same specification number, but have different nominal compositions of material.
- c. Both UNS Numbers are the same, but they are from different specifications and product forms.

P-Numbers, S-Numbers and UNS Numbers, may be used in the qualification of the welding procedure specification (Reference QW-424) and the qualification of the welders performance (Reference QW-423). The minimum specified tensile strength is to be used as one of the acceptance standards for the procedure qualification record tension tests (Reference QW-153). The nominal composition and product form are listed in Section IX only as a convenience for the Code user.

QW-253 references QW-403.11 which defines the P-Number limits of the base metals to be used for the qualification of the welding procedure specification (WPS). QW-403.11 refers the Code user to QW-424 to determine the extent of base metals which may be specified on a WPS, based upon the base metal used for the PQR test coupon. QW-424 applies only to the WPS and the PQR.

There are additional rules in QW-403.13 for base metals of P-Number 5, P-Number 9, and P-Number 10. Basically, QW-403.13 reminds the Code user to be aware that each of these P-Numbers have been further divided. For example, P-Number 5 has been divided into P-Number 5A, P-Number 5B, and P-Number 5C, and each must be treated as separate P-Numbers.

For the qualification of welders, QW-353 references QW-403.18 to cover the P-Numbers of the base metals to be used. QW-403.18 refers the Code user to QW-423 to determine the extent of the base metals for which the welder is qualified. QW-423 applies only to the WPQ.

The examples in Table 4.6, illustrate how QW-424.1 may be used for the qualification of the WPS by the PQR tests and, for the same applications, how QW-423.1 may be used for the qualification of the welder and preparation of the WPQ. [Interpretations IX-83-106 and IX-89-05 cover some unique applications of these rules.]

**Example 4.6.1** The application is an ASTM A 105 flange to an ASME SA-516 base metal. These are both P-Number 1 base metals (reference Table 4.5; QW/QB-422). Example 4.6.1 illustrates that the WPS may specify base metals of P-Number 1 to P-Number 1. To support this WPS, QW-424 states that the PQR test coupon must be welded using a P-Number 1 base metal to any other P-Number 1 base metal. In Example 4.6.1, two ASME SA-36 plates were chosen as the PQR test coupon. In this case, QW-424 states that this PQR may support any metal assigned to P-Number 1, welded to itself or any other P-Number 1 material.

According to QW-423.1, the welder may use any P-Number 1 through P-Number 11, P-Number 34, P-Number 4X and unassigned metals of similar chemical composition to these metals for the WPQ test coupon. The use of any of these base metals for the WPQ test coupons will qualify the welder for welding all base metals of P-Number 1 through P-Number 11, P-Number 34, P-Number 4X, and unassigned metals of similar chemical composition to these metals. Keep in mind, however, the welder will be able to weld each of these base metals, but only with the filler metal(s) used during qualification. The Code user must also have properly qualified WPSs if welding is to be done on Code items.

**Note:** P-Number 4X refers to the nickel base alloys of P-Number 41 through P-Number 47.

**Example 4.6.2** The application is an ASTM A 105 forging welded to an ASME SA-240 type 304 shell which is a P-Number 1 to a P-Number 8 (reference Table 4.5; QW/QB-422) application as shown in Figure 4.5. The WPS could specify P-Number 1 to P-Number 8 base metals, which would require a PQR test coupon of P-Number 1 to P-Number 8 base metals. Example 4.6.2 illustrates that the PQR was an ASME SA-36 plate to an ASME SA-240 type 304 plate test coupon. According to QW-424.1, this PQR test coupon qualifies the WPS for all P-Number 1 to P-Number 8 applications, but does not qualify for either P-Number 1 to P-Number 1 nor P-Number 8 to P-Number 8 base metals. The welder would not have to be requalified for QW-403.18, the welders variable for P-Numbers. QW-403.18 references QW-423.1 which allows the WPQ test coupon of Example 4.6.1 to also qualify the welder for the Example 4.6.2 application.

**Example 4.6.3** The application is an ASME SA-106 pipe welded to an ASME SA-335 P11 pipe which is a P-Number 1 to a P-Number 4 (reference Table 4.5; QW/QB-422). According to QW-424.1, a P-Number 4 PQR test coupon (ASME SA-387 Grade 11, Class 1 plate) will qualify the WPS for P-Number 4 to P-Number 4, and P-Number 4 to P-Number 3, and P-Number 4 to P-Number 1 applications. The P-Number 4 test coupon will not, however, qualify the WPS for P-Number 3 to P-Number 3, nor P-Number 1 to P-Number 1, nor P-Number 3 to P-Number 1 applications.

According to QW-423.1, the WPQ test coupon of Example 4.6.1 also qualifies the welder for the Example 4.6.3 as also described in Example 4.6.2.

**Example 4.6.4** The application is an AISI 1018 plate material, an unassigned metal, is welded to an ASME SA-106 pipe, which is a P-Number 1 base metal (reference Table 4.5; QW/QB-422). According to QW-424.1, a P-Number 1 to an AISI 1018 PQR test coupon will qualify the WPS for AISI 1018 metals welded to any base metals listed as a P-Number 1 base metal.

# Chapter 5

## **SAMPLE WPS, PQR AND WPQ DOCUMENTATION**

This chapter provides sample WPS, PQR, and WPQ, prepared and qualified for a specific application. These documents will be referenced as each rule and variable is described in the chapters which follow. These sample documents provide a reference point as this guide weaves itself through the many complex rules and variables.

The samples are:

- Table 5.1 (WPS # 134), prepared for welding carbon steels with the SMAW process with an E6010 root and an E7018 fill and cover, without PWHT or notch toughness requirements.
- Table 5.2 (PQR # Q134), prepared to qualify the variable ranges of WPS # 134 (Table 5.1).
- Table 5.3 (WPQ # 342), WPQ record prepared for a welder that must use WPS # 134.

The samples list the Code paragraph number of each variable on these documents, providing a ready reference for the Code user. Some companies use this technique for their own reference, since it is difficult to keep track of each of these variables and rules. Others plug in the data without Code paragraph references, making it difficult to find relevant information, and to verify if the documents have been properly prepared. This guide also provides a checklist in Chapter 9 to assist the Code user in verifying existing documentation.

**WPS # 134 (Table 5.1)** was prepared with the welder in mind. The variables, which are of primary interest to the welder were put on the first page of the WPS. The variables which are not of much interest to the welder were put on the second page. The details specified or recorded in each of these samples is generally the minimum required to address the variable.

**Caution:** Much more detailed information may be required for each variable for an actual application.

Page 3 of 3 was added at the end of the WPS. The attachment sheet is a convenient manner to specify a family of groove designs, which may frequently be changed.

Figure 5.1, illustrating starting and stopping techniques, was placed on page 1 of WPS # 134 to show how special information, specific to the current job, could be shown on page 1 for the welder.

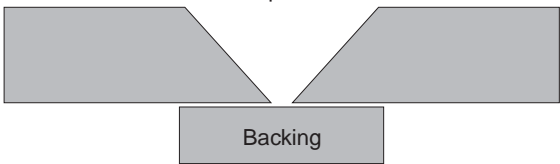
The WPS, PQR and WPQ may be prepared in any format to fit the needs of each Code user, as long as every essential, nonessential (outlined in QW-250 or QW-350), and when required, supplementary essential variable (outlined in QW-250) for each process is described, addressed or referenced in some manner.

Table 5.1 WPS # 134, page 1 of 3

<b>Company Inc.</b>			
<b>Welding Procedure Specification # 134</b>			
Revision -0-		Date: 01 Aug 1987	
Page 1 of 3			
For welding carbon steels with E6010 & E7018 fillers, without PWHT. (not qualified for notch toughness or impact tested applications)			
Revision -1- Authorized for use by: Peat McSquinty		Date: 06Oct98 Supporting PQRs: # Q134	
QW-401 Welding Processes	Shielded Metal Arc Welding (SMAW), manual,		
QW-404.33 Filler metal specification	SFA-5.1	SFA-5.1	
QW-404.33 Filler metal classification	AWS E6010	AWS E7018	
QW-404.4 F-Number	F-Number 3	F-Number 4	
QW-404.5 A-Number	A-Number 1	A-Number 1	
QW-404.30 Weld metal thickness "t <sub>d</sub> ".	3/16 in. maximum	3/16 in. maximum	
QW-403.11 P-Number	P-Number 1 Plain Carbon, Low Carbon or- Mild Steels		
QW-403.7 & 403.8 Base metal thickness "T"	1/16 in. minimum through 3/4 in. maximum		
QW-402.1 Groove Design	As shown on this WPS -or- on the repair plan, or inspection check-off plan.		
QW-402.4 Backing	See page 2 and the repair or check-off plan		
QW-402.10 Root spacing	As shown on this WPS -or- on the repair plan, or inspection check-off plan.		
QW-402.11 Retainers	No ceramic or non-fusing metal retainers		
QW-410.5 Type of cleaning	Brush or grind free of rust, dirt and scale 4 in. from the edge of the weld preparation.		
QW-405.1 Position/ QW-405.3 progression	All positions, upward progression.		
QW-406.1 Preheat	200°F minimum preheat for the E6010 50°F minimum preheat for the E7018.		
QW-406.2 Preheat maintenance	No preheat maintenance required.		
QW-410.1 Type of weld bead	"Optional" May use string and/or weave beads		
QW-410.5 Type of back gouging	Any mechanical or thermal method		
QW-410.26 Peening	Do not peen the first nor the last pass		
QW-409.4 / QW-409.8 Electrical values	Direct Current, reverse polarity.		
<b>Filler</b>	<b>Diameter</b>	<b>Amperage</b>	<b>Comments:</b>
E6010	3/32 in.	40-80	1. Start travel opposite direction of weld.
E6010	1/8 in.	75-125	2. Reverse direction when arc initiates.
E6010	5/32 in.	110-170	3. Weld over start to reduce porosity.
E7018	3/32 in.	40-150	4. Near end of the weld.
E7018	1/8 in.	105-165	5. Reverse direction of travel.
E7018	5/32 in.	150-220	6. To fill crater when breaking arc.
Figure 5.1			

Figure 5.2 through 5.5 were included at the end of WPS # 134 to illustrate some methods of bringing specific welding details to the attention of the welder, the supervisor, and the inspector.

Table 5.1 WPS # 134 page 2 of 3

<b>Company Inc.</b>	
<b>Welding Procedure Specification # 134</b>	
Revision -0-	Date: 01 Aug 1987 <span style="float: right;">Page 2 of 3</span>
Revision -1- Authorized for use by: Peat McSquinty <span style="margin-left: 100px;">Date: 06Oct98</span> <span style="float: right;">Supporting PQRs: # Q134</span>	
QW-402.4 Backing	Qualified for welding with or without backing. The backing shall be a P-Number 1 base metal, or weld metal of one of the filler metals on this WPS. Also qualified for fillet welds, partial penetration groove welds and weld metal buildup of base metals.
QW-403.13 P-Numbers (5 / 9 /10)	This WPS is applicable only for P-Number 1 base metals. QW-403.13 is not applicable
QW-403 Pipe diameter This is not a variable required by Section IX, but is a limitation of Co. Inc.	1 inch minimum outside diameter for butt welds. There is no minimum diameter for fillet welds.
QW-403.9 Single pass weld metal thickness "t <sub>d</sub> "	Not qualified to deposit more than ½ inch thick weld metal in a single weld pass.
QW-407.1 Post Weld Heat Treatment	PWHT shall not be applied.
QW-407.4 PWHT above the Upper TT	Not applicable (No PWHT applied).
<p>Single "V" may be used with backing or open root</p>  <p>Root spacing for open root: <math>\frac{3}{32} \pm \frac{1}{32}</math>" Root spacing with backing: <math>\frac{1}{8} \pm \frac{1}{8}</math>"</p> <p><b>Figure 5.2</b></p>	

# Chapter 6

## ***HOW TO PREPARE AND REVIEW A WPS***

This Chapter provides the Code user with detailed instructions for preparing a Welding Procedure Specification (WPS). This will also assist the Code user that must review WPSs to assure that they are properly prepared, appropriate for the application, and properly supported by a Procedure Qualification Record (PQR) (Chapter 7).

The following list provides basic information for preparing and reviewing a WPS.

The Code User shall:

- be responsible for having a WPS prepared.
- be responsible for all of the contents of the WPS, but may have the preparation of a WPS subcontracted,
- follow all the rules of the ASME Code Section IX.
- prepare each WPS to provide direction for “what the Code User intends to weld”.
- prepare each WPS to provide direction for the welder, inspector, and supervisor.
- specify ranges for each welding variable as required by QW-250 and other details as required by Section IX. Section IX lists the welding variables for each process in QW-250. [See Interpretation IX-89-03, question #1 for more details.]
- qualify each WPS by welding of test coupons under the supervision of the Code user. These tests and the test results shall be recorded on one or more PQRs.
- list the supporting PQR(s) on the WPS.

A reviewer of a WPS should verify that:

- each WPS has an entry for every essential, (supplementary essential variable when required) and nonessential variable, as listed for the process in QW-250.
- the WPS covers the ranges for the welding application for each variable listed for each process, as specified in QW-250.
- the WPS meets all other requirements of Section IX.
- that the WPS meets all requirements of the construction code or contract of record.
- the WPS is properly supported by one or more PQRs, and the supporting PQRs are listed on the WPS.
- every variable range on the WPS is being followed during fabrication or repairs.

Figure 6.1 covers some of the basic requirements for the Code user identification block of an ASME Section IX WPS form using circled numbers on the form with the corresponding requirements described below. There are no rules for any entry in the Code user identification block, nor for any arrangement of the information (QW-200.1(d)). Figure 6.1 is patterned after QW-482 (Figure 2.1) since most WPS forms use a similar identification block.



Company Name <u>① CO INC.</u> by <u>② (not required by rules of IX)</u> Welding Procedure Specification <u>③ #134 (no rules for numbering)</u> Date <u>④ 01 August 87</u> Revision No. <u>⑤ 1</u> Date <u>⑥ 06 October 1998</u> by <u>⑦ Peat McSquinty, Welding Engineer</u> Supporting PQR No.(s) <u>⑧ # Q134</u> Process <u>⑨ SMAW (Stick welding)</u> Type <u>⑩ Manual</u> ⑪ For welding carbon steels with E6010 & E7018, without PWHT, (not qualified for notch toughness or impact tested applications)
--

Figure 6.1 Code user identification block.

① The Code user should use the same name that the Code user has in the quality control manual. This would normally be the name used when obtaining the certificate of authorization from ASME or the National Board. This Code user name may be used on numerous documents and items, so it is prudent to use the shortest possible version of the Code user name. (Table 5.1, WPS # 134, Company Inc.).

② QW-482 (Figure 2.1) has always had a space on the form after the company name entitled “By:”. This was intended to be for the Code user's authorization or certification to use the WPS. The quality program for most organizations requires one or more signatures authorizing a WPS for use in its intended application. Section IX, however, has no rules that the WPS be certified. A WPS is a vital document, which provides direction for making Code welds, and it is strongly recommended that Code users establish a protocol for the review, certification, and authorization of the WPS. (In Table 5.1, WPS # 134, the certification block is near the top of page 1 of 3 and was signed by Peat McSquinty.)

③ There are no rules in Section IX for a WPS numbering system. A good quality program, however, should require a unique identification be assigned for each WPS. Keeping computers in mind, the numbering system may be sequential, such as 1, 2, 3, or may be related to the contents as used in Table 5.1 (WPS # 134) as shown below.

WPS # 134:	1 = ASME P-No. 1	(Carbon Steel Base Metals)
	3 = F-No. 3	(E6010) SMAW
	4 = F-No. 4	(E7018) SMAW

④ The date that the WPS was certified or authorized in ② is normally used in this space.

⑤ QW-200.1(c) allows changes to be made to a WPS provided such changes are documented by revision or amendment. When a WPS is amended it should be documented including a revision level.

⑥ The revision or amendment should be dated on the WPS per QW-200.1(c).

⑦ The revision or amendment should be certified or authorized as detailed in ②. (Table 5.1, WPS # 134, listed the revision level at the top in the company identification block).

⑧ QW-200.1(b) requires the WPS to reference its supporting PQRs. The supporting PQRs are normally noted in this identification block. (Table 5.1, WPS #134, listed the supporting PQR # Q134, at the bottom of page 1 of 3 on the certification line.) **Note:** It may take more than one PQR to support all the essential variable ranges specified in a WPS.

⑨ The welding process is not listed as an essential variable in QW-253 (Table 6.1), but is noted as an essential variable in QW-401. The welding process is shown on QW-482 (Figure 2.1) in the identification block, and in Table 5.1, WPS # 134, as the first variable listed.

⑩ QW-410.25 is a nonessential variable “type of process”, that must be described on the WPS. The type of welding is normally noted with the welding process, in the identification block. (Table 5.1, WPS # 134, listed “manual” as the process type on page 2, on the line, QW-410.25).

Each welding process may be one or more of the following: manual, semi-automatic, machine, or automatic. The following illustrates some of the common welding processes and the types of processes that are normally associated with welders and welding operators. A part or all of the Section IX definition is stated first, with additional comments in parenthesis.

Welder:	One who performs a manual or semiautomatic welding operation. (A welder holds and has manipulative control of the welding torch or the electrode holder).
Welding operator:	One who operates machine or automatic welding equipment. (A welder becomes a welding operator when the welding equipment holds the welding torch).
Machine Welding:	Welding with equipment, which performs the welding operation under the constant observation and control of a welding operator. (The welding operator controls machine welding, where adjustments may be made while welding).
Automatic Welding:	Welding with equipment, which performs the welding operation without adjustment of the controls by a welding operator. (The welding is considered automatic when the welding operator cannot make adjustments while welding).

<u>Welder or Operator</u>	<u>Process</u>	<u>Process Type</u>	<u>Comments</u>
Welder	SMAW, GTAW	manual	hand held torches or electrode holders
Welder	GMAW, FCAW, SAW	semi-automatic	wire fed hand held torches
Welding Operator	GMAW, FCAW, GTAW, SAW	machine	adjustments can be made by welding operator
Welding Operator	GMAW, FCAW, GTAW, SAW	automatic	adjustments can not be made by welding operator

⑪ There is no specified requirement for a description of what the WPS covers, but these descriptions are very helpful after the Code user has established a procedure qualification program with multiple WPSs. When a Code user has prepared dozens of WPSs, they all begin to look alike. A brief description may prove to be very beneficial when retrieving or assigning WPSs. (Table 5.1, WPS # 134 noted “For welding carbon steels with E6010 & E7018 without PWHT, (not qualified for notch-toughness or impact tested applications.”) This block may be used for any description needed by the Code user for a convenient, quick reference.

The balance of this chapter is a review of the requirements of a WPS, using the SMAW process for applications where notch-toughness is *not* a requirement. This chapter therefore, will not cover the supplementary essential variables. See Chapter 14 for supplementary essential variable conditions.

This chapter uses the variables as required by QW-253 (Table 3.3) for the SMAW process. To simplify this basic review of a WPS, Table 6.1 was prepared using the same information as Table 3.3 (QW-253). The supplementary essential variables have been removed. QW-200.1(b) requires that each essential and nonessential variable listed for the process be addressed on a completed WPS. Hence, for the SMAW process (when supplementary essential variables are not required), each variable as shown in Table 6.1 must be addressed on the WPS.

WPS # 134 (Table 5.1) is used as the model for each example throughout this chapter, with the exception of the identification block, Figure 6.1, which used the QW-482 sample format.

This chapter shows various methods of addressing the variables in a WPS. There is no consideration given to the qualification of these variables, simply how to address the variable on the WPS. A Code user simply specifies in a WPS the application ranges needed for each variable. A Code user must then evaluate the essential variables required to qualify the application ranges specified in the WPS. Chapter 7, How to Prepare or Review a PQR, shows how to record each essential variable on a PQR, and gives various methods of addressing the qualification rules for each of the variables.

Table 6.1 lists all the variables for the SMAW process by groups of variables. Table 6.2 lists the first group of variables, QW-402, Joints. In Table 6.2 the first variable, QW-402.1 has been shaded. Shadings high light that QW-402.1 will be discussed following Table 6.2. The basics of QW-402.1 are stated, followed by examples of how to apply the variable. Each new variable, or group of variables, begins with a bolded title, such as: **QW-402-Joints, Groove Design**, for Table 6.2. Table 6.3 specifically describes QW-402.4 Backing, QW-402.10 Root Spacing and QW-402.11 Retainers.

Table 6.1 QW-253, Essential and Nonessential Variables for SMAW

<b>QW-253 WELDING VARIABLES PROCEDURE SPECIFICATIONS (WPS)</b>				
<b>Shielded Metal-Arc Welding (SMAW)</b>				
<b>Paragraph</b>		<b>Brief of Variables</b>	<b>Essential</b>	<b>Nonessential</b>
QW-402 Joints	.1	φ Groove design	...	NE
	.4	- Backing	...	NE
	.10	φ Root spacing	...	NE
	.11	± Retainers	...	NE
QW-403 Base Metals	.7	T/t limits > 8 inch (203 mm)	E	...
	.8	φ T qualified	E	...
	.9	t pass > ½ in.	E	...
	.11	φ P-No. qualified	E	...
	.13	φ P-No. 5/9/10	E	...
QW-404 Filler Metals	.4	φ F-Number	E	...
	.5	φ A-Number	E	...
	.6	φ Diameter	...	NE
	.30	φ t	E	...
	.33	φ AWS class	...	NE
QW-405 Positions	.1	+ Position	...	NE
	.3	φ ↑↓ Vertical welding	...	NE
QW-406 Preheat	.1	Decrease > 100°F (56°C)	E	...
	.2	φ Preheat maintenance	...	NE
QW-407 PWHT	.1	φ PWHT	E	...
	.4	T limits	E	...
QW-409 Electrical	.4	φ Current or polarity	...	NE
	.8	φ I & E range	...	NE
QW-410 Technique	.1	φ String / weave	...	NE
	.5	φ Method cleaning	...	NE
	.6	φ Method back gouge	...	NE
	.9	φ Multiple to single pass/side		
	.25	φ Manual or automatic	...	NE
	.26	± Peening	...	NE

The first rule for determining how each variable is applied, is to review the specific variable of QW-253 (Tables 3.3 and 6.1), such as QW-402.1,  $\phi$  Groove Design. Do not attempt to comprehend the details of a variable from the description noted in the “Brief of Variables” column. Read the actual variable, such as QW-402.1, “A change in the type of groove (Vee-groove, U-groove, single-bevel, double-bevel, etc.).” Errors are made when the Code user implements a variable based upon the “Brief of Variables” description.

## QW-402 Joints – Groove Design

Table 6.2 QW-402.1, Groove Design

QW-253 WELDING VARIABLES PROCEDURE SPECIFICATIONS (WPS)				
Shielded Metal-Arc Welding (SMAW)				
Paragraph		Brief of Variables	Essential	Nonessential
QW-402 Joints	.1	$\phi$ Groove design	...	NE
	.4	- Backing	...	NE
	.10	$\phi$ Root spacing	...	NE
	.11	$\pm$ Retainers	...	NE

Table 6.2 will be used to demonstrate how variables can be addressed on a WPS. Table 6.2 represents the QW-402 Joints group of variables for the SMAW process. Table 6.2 contains only essential and nonessential variables. The supplementary essential variables column has been removed. Code user finds the first application variable for the process, QW-402.1,  $\phi$  Groove design. This variable has been shaded in Table 6.2. Variable QW-402.1 states: “A change in the type of groove (Vee-groove, U-groove, single bevel, double bevel, etc.).”

When preparing the WPS, it does not matter if the variable is essential or nonessential. The WPS must address each variable listed for the process. QW-402.1 may be addressed by stating on the WPS which types of grooves may be used with the WPS.

WPS # 134 (Table 5.1) addressed this groove design variable on page 1 of 3 by stating: “QW-402.1 Groove Design - As shown on this WPS (**Note:** this would permit the application to be welded using any of those groove designs shown on WPS # 134 in Figure 5.2 on page 2 of 3, and Figures 5.3 through 5.5 on page 3 of 3, but could not use any other groove design, unless) -or- on the repair plan, or inspection check off plan. (**Note:** this note extends the groove design to any specified on the repair plan or inspection check off plan.) The names of the documents, which may be used to specify groove designs, are not important, so long as they are referenced for use by the WPS.

**Example 6.2.1** Groove details may also be specified by reference on the WPS to:

- production drawings
- fabrication plans
- shop sketches

provided the joint design is available for reference by the:

- welder
- inspector (Code user’s)
- supervisor
- Authorized Inspector (AI, NBCI, or API 510 Inspectors)

**ASME SFA-5.1 (AWS A5.1)****Specification For Covered Carbon Steel Arc Welding Electrodes (Excerpt)**

1. Scope—This specification prescribes requirements for the classification of covered carbon steel electrodes for shielded metal-arc welding.
2. Classification
  - 2.1 The welding materials covered by this specification are classified according to the following criteria:
    - (1) Type of current.
    - (2) Type of covering.
    - (3) Welding position of the electrode.
    - (4) Mechanical properties.
  - 2.2 Materials classified under one classification shall not be classified under any other classification of this specification.
3. Acceptance—Acceptance of electrodes shall be in accordance with AWS A5.01.
4. Certification—The AWS specification and classification on the packaging certifies that the manufacturer has met this specification.
6. Tests—This specification defines all the tests the manufacturer of the electrode must make when required by the purchaser in accordance with AWS A5.01.
22. Electrode Identification
23. Packaging
24. Marking

The following is an excerpt from the ASME SFA-5.1 (AWS A5.1) Appendix - Guide to Classification of Carbon Steel Covered Arc Welding Electrodes. Similar guides are found in the other ASME SFA-5.X (AWS A5.X) specifications. These guides will assist in meeting the requirements of QW-404.33.

**ASME SFA-5.1 (AWS A5.1)****Guide to Classification of Carbon Steel Covered Arc Welding Electrodes (Excerpt)****A1 Introduction**

This guide was intended to correlate electrode classifications with applications as examples rather than a complete listing of the filler metal / base metal combinations.

**A2 Classification System**

**A2.1** The classification system used in the specification follows the established pattern for AWS filler metal specifications. The letter E designates an electrode. The first two digits, 60, for example, designate tensile strength of at least 60 ksi of the deposited metal, weld metal in the as-welded condition. The third digit indicates the position in which satisfactory welds can be made with the electrode. Thus, “1” (as in E6010) means that the electrode is satisfactory for use in all positions (flat, vertical, overhead, and horizontal). The “2” (as in E6020) indicates that the electrode is suitable for the flat position and also for making fillet welds in the horizontal position. The last two digits taken together indicate the type of current with which the electrode can be used and the type of covering on the electrode, as listed in Table 1.

**A2.2** Optional designators are also used in this specification to identify electrodes that have met the mandatory classification requirements and certain supplementary requirements as agreed between the supplier and the purchaser. For example the *-1* in an E7018-1 identifies an electrode, which meets optional supplemental impact requirements at a lower temperature than is required for the plain E7018 electrode. Other designators are *R* for moisture resistant, *HZ* for diffusible hydrogen content, *M* for all of the above.

## **A6** Welding Considerations

**A6.3** Hydrogen is another factor involved. Weld metals, other than those from low hydrogen electrodes (E7015, E7016, E7018, E7028, and E7048) contain significant quantities of hydrogen for some period of time after they have been deposited. This hydrogen gradually escapes. After two to four weeks at room temperature or in 24 to 48 hours at 200 to 220 degrees F (95 to 105 degrees C), most of it has escaped. As a result of this change in hydrogen content the yield, tensile, and impact strength remain relatively unchanged, but the ductility of the weld metal increases toward its inherent value.

**A6.4** When weld deposits are given a post weld heat treatment, the temperature and time at temperature are very important. The following points from SFA-5.1 Appendix: *Guide to...* concerning post weld heat treatment (stress relief, in this case) should be kept in mind. The tensile and yield strengths generally are decreased as stress relief temperature and time at temperature are increased.

**A6.11.1** Hydrogen can have adverse effects on welds in some steel under certain conditions. One source of this hydrogen is moisture in the electrode coverings. For this reason the proper storage, treatment, and handling of electrodes are necessary.

**A6.11.4** Cellulose coverings for E6010 electrodes have moisture levels of 3% to 7%; therefore, storage or conditioning above ambient temperature may dry them too much and may adversely affect their operation.

## **A7** Description and Intended Use of Electrodes

**A7.1.1** E6010 Classification electrodes are characterized by a deeply penetrating, forceful, spray type arc and readily removable, thin friable slag, which may not seem to completely cover the deposit. Fillet welds are usually relatively flat in profile and have a rather coarse, unevenly spaced ripple.

**A7.1.2** These electrodes are recommended for all-position work, particularly on multiple pass applications in the vertical and overhead positions and where welds of radiographic soundness are required.

**A7.1.3** The majority of applications for these electrodes is in joining carbon steel. However, they have been used to advantage on galvanized plate and on some low alloy steels. Typical applications include shipbuilding, structures such as buildings and bridges, storage tanks, piping, and pressure vessel fittings.

**A7.6.1** Electrodes of the low hydrogen classifications are made with inorganic coverings that contain minimal moisture.

**A7.6.3** In order to maintain low hydrogen, electrodes should be stored and handled with considerable care. Electrodes exposed to moisture may lose their characteristics. Reconditioning may restore the low hydrogen characteristics.

**A7.6.4** Low hydrogen electrodes designed to resist moisture are designated -R.

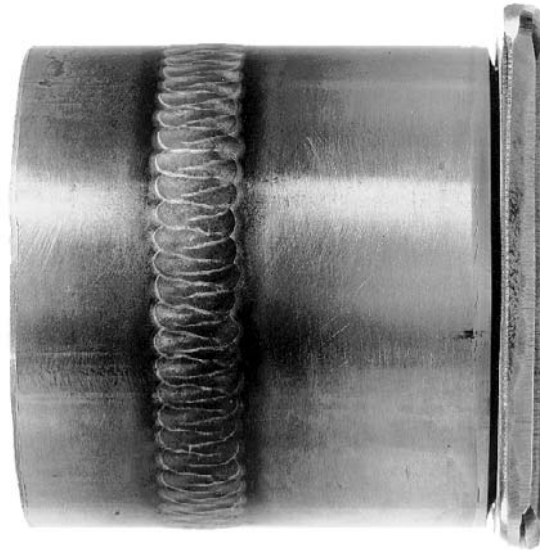


Figure 6.6 Weave bead pipe cap weld.

ASME Section VIII, Division 1, UW-32(a) requires base metals to be cleaned prior to welding. OSHA requires the area be cleaned 4 in. from the edge of the weld joint preparation. Whatever is specified on the WPS must be followed, so make certain everyone understands what is required.

Another example where the construction code specifies requirements in addition to Section IX is ASME Section VIII, Division 1 UW-39 (a) which states that it is not permitted to peen the first or the last pass of a weld unless the weldment is subsequently given a PWHT. Removal of slag is not considered peening [Interpretation VIII-1-83-255]. The work hardening effect of peening may be minimized, however, by the use of flapper wheels, rotary wire wheels, needle scalers or shot blast for removing weld slag. Some of these nonessential variables may require detailed descriptions in order to meet the requirements of the construction code.

# Chapter 7

## ***HOW TO PREPARE AND REVIEW A PQR***

This chapter provides the Code user with detailed instructions for preparing a procedure qualification record (PQR). This chapter will also assist the Code user who must review PQRs to assure that they are properly prepared, that the tests and test results are satisfactory, and that the PQR(s) properly supports the welding procedure specification WPS(s).

The Code User wishing to qualify a WPS(s) must:

- prepare a PQR by welding a test coupon and recording the essential variables on the PQR, for each process used. Ensure the test coupon is cut into specimens and be tested. The test results shall be recorded on a PQR to provide a record of “what was welded, tested and the test results.”
- record the actual ranges used for each essential variable as required by QW-250 for each welding process used. Additional nonessential variables or any other reference information may be recorded on a PQR, but a PQR is only governed by the essential variables (QW-200.2(b)).
- be responsible for supervising the welding of all PQR test coupons (QW-201).
- be responsible for the results of the PQR tests (QW-201). The testing of PQR test coupons may be subcontracted.
- prepare each PQR following all the rules of ASME Section IX and the construction code.
- prepare one or more PQRs to support each WPS.

A reviewer of a PQR should verify that:

- each PQR covers the ranges for the intended WPS it is supporting, that the actual range used is recorded for each essential variable for each process, as specified in QW-250, and that the PQR has the proper tests and test results documented, and the PQR has been certified by the Code user.
- the Code user's identification block on the PQR form has the proper Code user name and other details as defined for WPS (See Figure 6.1).
- the PQR is certified by the Code user (QW-201, last paragraph).

**Caution:** Be aware of additional variables that may be required by Section IX or the construction code.

### **Variables**

This chapter reviews the requirements for a PQR, with most examples related to welding using the SMAW process for applications where *notch-toughness is not a requirement*. Therefore, the supplementary essential variables are not applicable (see Chapter 14 for supplementary essential variables and notch-toughness requirements). This chapter uses the variables as required by QW-253 (Table 3.3) for the SMAW process. To simplify this basic review of a PQR, Table 7.1 was prepared with the same information contained in Table 3.3 (QW-253), but has had the nonessential and supplementary essential variables removed. (Table 7.1 therefore represents a simplified version of QW-253 (Table 3.3),



with only the essential variables shown.) QW-200.2(b) requires that each essential variable listed for the process be addressed on a PQR. Hence, for any SMAW process, each variable shown in Table 7.1 shall be addressed on a PQR.

Table 7.1 QW-253, Essential Variables for SMAW (Modified)

<b>QW-253</b>			
<b>Welding Variables Procedure Specifications (WPS)</b>			
<b>Shielded Metal-Arc Welding (SMAW)</b>			
<b>Paragraph</b>	<b>Brief of Variables</b>		<b>Essential</b>
QW-403 Base Metals	.7	T/t limits > 8 inch (203 mm)	E
	.8	φ T Qualified	E
	.9	t Pass > ½ inch (13 mm)	E
	.11	φ P-No. qualified	E
	.13	φ P-No. 5/9/10	E
QW-404 Filler Metals	.4	φ F-Number	E
	.5	φ A-Number	E
	.30	φ t	E
QW-406 Preheat	.1	Decrease > 100°F (56°C) (IP)	E
QW-407 PWHT	.1	φ PWHT	E
	.4	T limits	E

This chapter addresses each group of variables in Table 7.1. Table 7.2 addresses two groups of variables, both dealing with thickness. Table 7.2 covers QW-403 Base Metals, specifically, QW-403.7, T/t limits > 8 inches (203 mm), QW-403.8, φ T qualified, and QW-404 Filler Metals, specifically, QW-404.30, φ t.

The first rule for determining how each essential variable is to be applied, is to review the specific essential variable of QW-253 (Table 3.3), such as QW-403.8, φ T qualified. It is very difficult to understand and use the variable from the description noted in the “Brief of Variables” column. Read the actual variable, such as QW-403.8, “A change in base metal thickness beyond the range qualified in QW-451, except as otherwise permitted by QW-202.4(b).” The details of each essential variable shall be recorded on the PQR when the Code user understands the full requirement of the variable.

When addressing the WPS (Chapter 6), for the SMAW example, it was necessary to read each variable in Table 6.1 (QW-253), and specify a range for each of these variables on the WPS. To address the PQR for the SMAW example, it is necessary to read each essential variable in Table 7.1 (QW-253) and record the value used for each of these essential variables on the PQR. The essential variable may be a single value. For example, for QW-403.8, the actual thickness of the test coupon used must be recorded on the PQR. The essential variable may be a small range, such as for QW-406.1. A small range of preheat, for example; [200°F (93°C) minimum to 250°F (121°C) maximum] normally occurs, and this small range is to be recorded on the PQR. The preparation of a PQR with respect to the essential variables is simply recording the values of each applicable essential variable used during the welding of the PQR test coupon.

It is only after a WPS and a PQR have been verified as being properly prepared, that the Code user determines if the PQR or PQRs properly supports the WPS (See details in Chapter 9).

## QW-403 Base Metal Thickness and QW-404 Weld Metal Thicknesses

Table 7.2 (QW-253) lists QW-403.7 and QW-403.8 as essential variables. QW-403.7 applies when the PQR test coupon is 1½ inches (38 mm) thick or thicker, and only for the SMAW, SAW, GTAW and GMAW processes. QW-403.8 applies when the PQR test coupon is less than 1½ inches (38 mm) thick, for the processes listed in QW-403.7, and applies for all other processes, regardless of the PQR test coupon thickness.

Table 7.2 QW-403.7 and QW-403.8, Base Metal T and QW-404.30, Weld Metal t

QW-253 Welding Variables Procedure Specifications (WPS)			
Shielded Metal-Arc Welding (SMAW)			
Paragraph		Brief of Variables	Essential
QW-403 Base Metals	.7	T/t limits > 8 inches (201 mm)	E
	.8	ϕ T Qualified	E
	.9	t Pass > ½ inch (13 mm)	E
	.11	ϕ P-No. qualified	E
	.13	ϕ P-No. 5/9/10	E
QW-404 Filler Metals	.4	ϕ F-Number	E
	.5	ϕ A-Number	E
	.30	ϕ t	E

For the purpose of the PQR, the Code user need only verify that a value for each essential variable was recorded. PQR # Q 134 (Table 5.2), recorded a PQR test coupon thickness of ⅜ inch (10 mm), which covered both essential variables, QW-403.7 and QW-403.8, as both essential variables involve the thickness of the test coupon.

- QW-403.8 is used for determining the base metal thickness ranges in accordance with QW-451, within the limitations of QW-202.
- QW-404.30 is used for determining the weld metal thickness ranges in accordance with QW-451, within the limitations of QW-202.
- QW-202.2 contains many of the requirements, which apply to both the thickness of the base metal and the thickness of the weld metal. This rule is divided into three categories, as follows:
- QW-202.2(a) *Qualification for Groove Full Penetration Welds.*  
Groove-weld test coupons shall qualify the thickness ranges for both the base metal “T” and the weld metal “t”. Limits of qualification shall be in accordance with QW-451.
- QW-202.2(b) *Qualification for Partial Penetration Groove Welds.*  
Groove-weld test coupons shall qualify the thickness ranges for both the base metal “T” and the weld metal “t”. Limits of qualification shall be in accordance with QW-451. Test coupons  $T_c \geq 1\frac{1}{2}$  inch (38 mm) qualify for any upper base metal thickness.
- QW-202.2(c) *Qualification for Fillet Welds.*  
Fillet welds may be qualified by the Groove-weld tests of (a) or (b) and will be qualified for all thicknesses, sizes and diameters. Fillet welds may be qualified by fillet-weld tests, but only for nonpressure retaining fillet weld applications.
- QW-403.7 applies to four processes: SMAW, GTAW, GMAW, and SAW, and only when the test coupons are 1½ inches (38 mm) thick or thicker, in accordance with QW-451.

Table 7.3 Thickness Ranges of Base Metal “T” and the Weld Metal “t” for the WPS and PQR

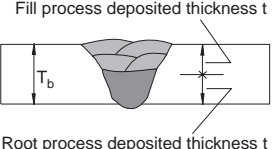
<p><b>Welding Application</b></p>  <p>Figure 7.1</p>	<p><b>WPS</b></p> <p>Specify:</p> <p>Variable ranges Essential variables Nonessential variables Other directions</p>	<p><b>PQR</b></p> <p>Record:</p> <p>Actual values Essential variables Tests and results Other data</p>	<p><b>WPQ</b></p> <p>Record: Specify: value range tested qualified</p> <p>Record tests and results</p>
<p>This table covers base metal QW-403.7 and QW-403.8 and weld metal QW-404.30 thickness ranges, including base metal and weld metal thickness rules of QW-202.2, QW-202.3, and QW-202.4.</p>			
<p>The Code user must read all the rules of Section IX which apply to both the WPS and the PQR. A prime example is QW-202 which guides the Code user to QW-451 for thickness limits for both base metal <math>T_b</math> and the weld metal <math>t_d</math>. The other QW-202.X paragraphs have exceptions and additional rules for <math>T_c</math>, <math>t_c</math>, <math>T_b</math>, and <math>t_d</math>. The following is an outline of what some of these paragraphs cover.</p>			
	<p>QW-403.8 Base metal thickness <math>T_b</math> for all processes per QW-451, except for QW-202.</p> <p>QW-404.30 Weld metal thickness <math>t_d</math> per QW-451.</p> <p>QW-202.2(a) Full penetration groove welds <math>T_b</math> &amp; <math>t_d</math>.</p> <p>QW-202.2(b) Partial penetration welds <math>T_b</math> &amp; <math>t_d</math>.</p> <p>QW-202.2(c) Fillet welds.</p> <p>QW-202.3 Weld repair and buildup.</p> <p>QW-202.3(a) Fillet weld exemptions.</p> <p>QW-202.3(b) Exemptions for test coupons <math>T_c</math> 1½ in. thick and thicker.</p> <p>QW-202.4 Dissimilar base metal thicknesses.</p> <p>QW-202.4(a) Thinner member must be within QW-451.</p> <p>QW-202.4(b)(1) Exemptions for test coupons <math>T_c</math> ¼ in. thick and thicker.</p> <p>QW-202.4(b)(2) Exemptions for test coupons <math>T_c</math> 1½ in. thick and thicker.</p> <p>QW-403.7 Base metal <math>T_b</math> for SMAW, GTAW, GMAW, &amp; SAW. Base metal <math>T_b</math> for test coupons <math>T_c</math> 1½ inch (38 mm) thick and thicker.</p>	<p>Performance qualification rules are found in QW-350</p>	

Table 7.4 has modified QW-451.1 to highlight how the thickness of the Test Coupon  $T_c$ , the thickness of the welding application base metal  $T_b$ , the thickness of the weld metal in the test coupon  $t_c$  and the thickness of the weld metal in the welding application  $t_d$  may be determined. Table 7.4 has further modified QW-451.1 by adding extra cells to explain each of the headings

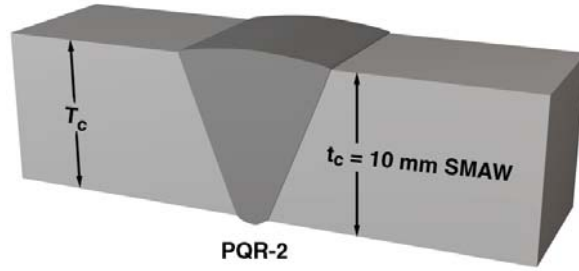


Figure 7.18 PQR-2.

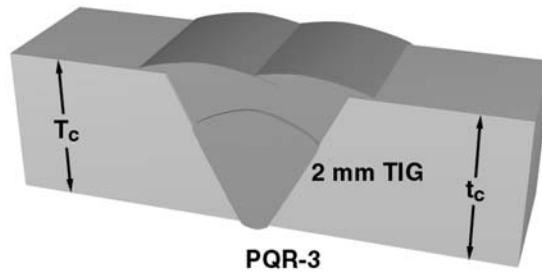


Figure 7.19 PQR-3.

Interpretation IX-79-88, volume 6, covers a combination WPS/PQR application.]

[Interpretations IX-80-49, volume 8 and IX-81-11, volume 9, have several inquiries, which support the need to qualify both the minimum and maximum base metal thicknesses involved.]

[Interpretations IX-86-01, IX-86-08, IX-92-77 and IX-92-97 cover the use of only one of the processes from a combination procedure and separate WPSs being used to make a combination weld.]

**QW-403 Base Metals, Pass “t” and QW-404 Weld Metal “t”**

Table 7.13 QW-404 Weld Metal Thickness and QW-403 Weld Pass Thickness

<b>QW-253 Welding Variables Procedure Specifications (WPS)</b>			
<b>Shielded Metal-Arc Welding (SMAW)</b>			
<b>Paragraph</b>	<b>Brief of Variables</b>		<b>Essential</b>
QW-403 Base Metals	.7	T/t limits > 8 inch (203 mm)	E
	.8	$\phi$ T Qualified	E
	.9	t Pass > ½ inch (13 mm)	E
	.11	$\phi$ P-No. qualified	E
	.13	$\phi$ P-No. 5/9/10	E
QW-404 Filler Metals	.4	$\phi$ F-Number	E
	.5	$\phi$ A-Number	E
	.30	$\phi$ t	E

# Chapter 8

## **TESTING REQUIREMENTS FOR PROCEDURE QUALIFICATION**

This Chapter provides the Code user with the testing requirements for the qualification of Welding Procedure Specifications (WPS). Test coupons must be welded, and the results of testing the specimens must be recorded on a Procedure Qualification Record (PQR). These welding procedure qualification tests are required to demonstrate the properties of the intended WPS.

Chapters 1 through 7 guided the Code user through the steps necessary to prepare the WPS and how to document the qualification tests on a PQR. This Chapter outlines 14 Code requirements, presented in a step by step manner, intended to guide the Code user for the preparation of the procedure qualification (PQR) test coupon, for preparing test specimens from the test coupon, and testing the specimens. The testing requirements for the qualification of welders and welding operators are covered in Chapter 11.

### **Outline of Testing Requirements for Chapter 8**

- Step 1 Code users responsibilities.
- Step 2 Preparation of test coupons.
- Step 3 Type and number of test specimens.
- Step 4 Alternative bend tests.
- Step 5 Fillet and stud welds.
- Step 6 Specimen removal.
- Step 7 Tension test methodology.
- Step 8 Tension specimen dimensions.
- Step 9 Bend test methodology.
- Step 10 Bend specimens.
- Step 11 Tension test procedure.
- Step 12 Bend test procedure.
- Step 13 Tension test acceptance criteria.
- Step 14 Bend test acceptance criteria.

#### **Step 1 Code Users Responsibilities**

Each Code user must qualify a WPS by welding test coupons, testing specimens and recording the welding data and test results in a document known as a procedure qualification record (PQR). The welders that produce weldments to be tested for qualification of procedures must be under the full supervision and control of the Code user during the production of these test weldments. It is not permissible to have the welding of the test coupons performed by another organization. Reference QW-201.

It is permissible to subcontract the work of preparing the test coupons for welding and subsequent work of preparing test specimens from the completed weldment, nondestructive examination, and mechanical testing, provided the Code user accepts the responsibility.

QW-201 allows for separate divisions, within an organization, to share welding procedure specifications and procedure qualification records.

One of the most important aspects of qualifying a WPS, is supervising the welding of the PQR test coupon. A Code user learns a good deal from the actual welding of the PQR test coupon. There are many Code details that are important to the proper qualification of the WPS. The Code user should provide the welder who is going to weld the PQR test coupon with verbal and written details so the PQR test is conducted in full accordance with Section IX and the code of construction.

QW-201 requires that the Code user certify that they have qualified each WPS, performed the procedure qualification test(s), and documented the variables, tests, and test results on the PQR. There are interpretations that state, for the purposes of ASME Section IX, that the PQR is required to be certified by the Code user.

Table 5.2, the sample PQR #134 demonstrates a method for the certification of the PQR tests and results. The sample PQR #134 has a Company Inc. Certification Block which identifies the welder and supervisor, both from Company Inc., the person and company who tested the specimens (iiii), and the person who reviewed and accepted the tests and results. A Company Inc. certification statement is followed by a certification and date. PQR #134 demonstrates more details than does QW-483, but the identification of additional personnel involved may help the Code user in the future.

## **Step 2 Preparation of Test Coupons**

QW-211 The base metals and filler metals must be one or more of those listed in the WPS. The base metals may consist of either plate, pipe, or other product form. Qualification on plate also qualifies for pipe welding and vice versa.

A basic premise of Section IX is that a PQR test coupon is prepared using essential variables, which are the variables designated by Section IX that affect mechanical properties.

The choice of test coupon form is at the discretion of the Code user, provided all essential variables and other Code requirements are met. Sound weld metal, for other than notch-toughness applications, is considered by Section IX, as having the same mechanical properties for a flat plate, round pipe, or irregular shaped forgings. The sample PQR #134 was made with two plates of 3/8 inch (9.6 mm) material, welded in the flat position.

## **Step 3 Type and Number of Test Specimens**

Paragraph QW-202.1, Mechanical Tests, states that QW-451 specifies the type and number of tests specimens which must be tested to qualify for groove welds. If any single test specimen required by QW-451 fails to meet the acceptance criteria (Steps 13 and 14), the test coupon has failed, and a new test coupon must be welded.

Table 8.1 has modified QW-451 to represent only the type and number of specimens required for groove-welded test coupons. Chapters 4 and 7 cover the other portion of QW-451.1, the base and weld metal thickness limits. PQR groove welded test coupons always require two tension test specimens and four bend test specimens. The bend test choice is between the side bends and the face and root bends.

Table 8.1 QW-451 Procedure Qualification Thickness Limits and Test Specimens

<b>QW-451.1 Groove Weld Tension Test and Transverse Bend Test</b>				
<b>Thickness (<math>T_c</math>) of Test Coupon Welded, in. (mm)</b>	<b>Type and Number of Tests Required (Tension and Guided-bend Tests) [Note (2)]</b>			
	<b>Tension QW-150</b>	<b>Side Bend QW-160</b>	<b>Face Bend QW-160</b>	<b>Root Bend QW-160</b>
< 1/16 (1.6)	2	...	2	2
1/16 to 3/8 (1.6 to 10) incl.	2	[Note (3)]	2	2
> 3/8 (10) to < 3/4 (19)	2	[Note (3)]	2	2
3/4 (19) to < 1 1/2 (38)	2 [Note (4)]	4	...	...
1 1/2 and over (38)	2 [Note (4)]	4	...	...
Notes:				
(2) For combination of welding procedures, see QW-200.4				
(3) Four side bend tests may be used for the face & root bends when $T_c$ or $T_s$ is $\geq 3/8$ in.				
(4) See QW-151 for details on multiple specimens when $T_c$ is over 1 inch (25 mm)				

**Caution Note:** A test coupon ( $T_c$ ) is normally two pieces of metal joined by welding. The test coupon ( $T_c$ ) is cut into test specimens ( $T_s$ ). These test specimens ( $T_s$ ) are individually examined or tested as bend tests, tension tests, impact tests, etc. Please note the subtle difference between  $T_s$  and  $T_c$  for the following.

QW-451.1 (Table 8.1) covers transverse bend tests (Figure 8.4). QW-463.1(a) or (b) (Figure 8.1) shows transverse bend specimens which are cut at right angles to the progression of the weld. QW-451.1 requires face and root bend test specimens when the test specimens  $T_s$  are less than 3/8 inch (10 mm). QW-451.1 requires side bend tests when the test coupon  $T_c$  is 3/4 inch (19 mm) and thicker. The type of bend test is optional when the test coupon  $T_c$ , or the test specimen  $T_s$ , is 3/8 inch (10 mm) up to but not including 3/4 inch (19 mm) thick.

**Example 8.1.1** When the final machined thickness of the test specimen  $T_s$  is less than 3/8 inch (10 mm), the thickness of the test specimen  $T_s$  should be used in the *Thickness ( $T_c$ ) of Test Coupon Welded, in.* column of Table QW-451.1 in place of the test coupon  $T_c$ . For example, QW-451.1 would seem to allow an option if an as-welded test coupon  $T_c$  is 1/2 inch (12.7 mm) thick, but if the prepared test specimen  $T_s$  is reduced in thickness to less than 3/8 inch (10 mm) thick, the test specimen must be face and root bend tested. See steps 9 and 10 of this chapter.

#### Step 4 Alternative Bend Tests

QW-202.1 provides an alternative bend test in QW-451.2 for special conditions.

QW-451.2 covers the longitudinal face and root bend tests, that is, the bend specimens are cut in the same direction as the progression of the weld. Longitudinal bend tests are to be used, at the Code users discretion, for test coupons where one base metal is much softer than the other, or when the base metal and the weld metal are markedly different in ductility.

**Step 5 Fillet and Stud Weld Tests**

QW-202.1 specifies the qualification for fillet welds only in QW-202.2(c) and (d) and for stud welds only in QW-202.5.

QW-202.2(c) specifies that nonpressure retaining fillet welds may be qualified per QW-451.3. These fillet-welded PQR tests do not verify the mechanical properties of a fillet weld, but rather, the soundness of the fillet weld metal. Therefore, qualification using a fillet-welded PQR test coupon does not qualify for groove-welded applications. Further, qualification using a fillet-welded PQR test coupon does not qualify for pressure retaining fillet-weld applications. The Section IX does not define nonpressure retaining. The scope and definition of nonpressure retaining must come from the code of construction.

QW-202.2(c) specifies that fillet welds may be qualified by the groove-weld tests of QW-202.2(a) or (b). Fillet weld procedure specifications (WPS) qualified using a groove welded PQR test coupon, are acceptable for pressure retaining applications for all fillet weld sizes, base metal thicknesses, and diameters in accordance with QW-451.4.

**Step 6 Specimen Removal**

QW-202.1 specifies that test specimens are to be removed in a manner similar to that shown in QW-463. QW-463.1(a), (Figure 8.1) is used as a guide for specimen removal for plate test coupons and QW-463.1(d) or (e) (Figure 8.2) is used as a guide for specimen removal for pipe specimens.

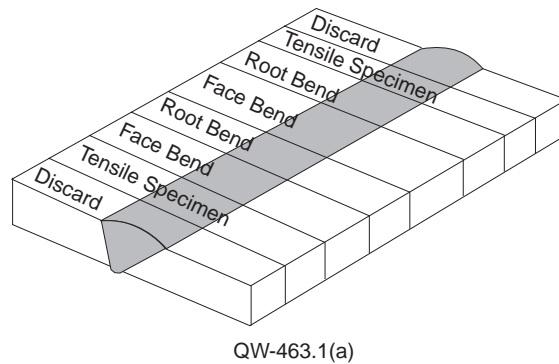


Figure 8.1 QW-463.1(a) specimen order of removal.

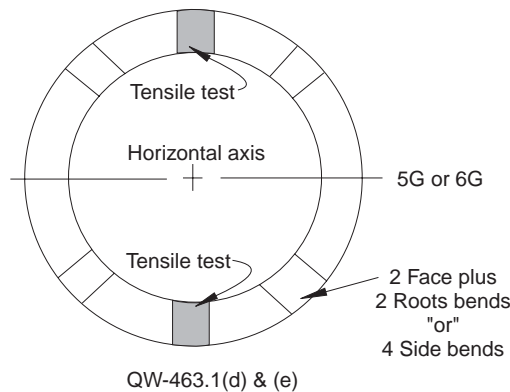


Figure 8.2 QW-463.1(d) & (e) Specimen order of removal.



sample PQR # Q134 (Table 5.2) and Table 8.2 therefore meet the minimum requirements of Section IX, since QW-483 is only a suggested format in a non-mandatory appendix.

The machined tension specimen  $T_s$  dimensions and the calculations shown in Table 8.2 are used to determine the ultimate tensile strength of the PQR test coupon. The as-welded PQR test coupon thickness  $T_c$ , not the final machined dimension of the PQR test specimens  $T_s$ , is used to determine the thickness range  $T_b$  which may be specified on the WPS. [Interpretation IX-81-33 and IX-83-94 verify these comments.]

A reduced section tension specimen  $T_s$  is removed from a plate test coupon,  $T_c$ , transverse to the direction of the weld (Figure 8.7). The minimum weld metal reinforcement and distortion of the test coupon are machined until approximately parallel sides of sound weld metal are obtained.

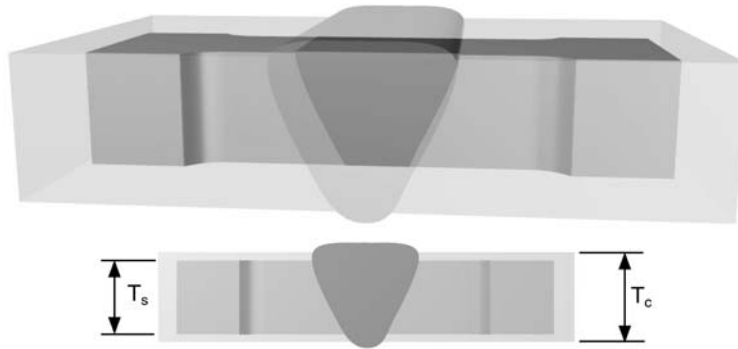


Figure 8.7 QW-151(a) Tension test specimen.

An NPS 5 Schedule 80 pipe,  $\frac{3}{8}$  inch (9.6 mm) thick wall, ASME SA-106 Grade B, with a 60 ksi (415 MPa) minimum specified tensile strength from QW/QB-422 may be reported as in Table 8.3.

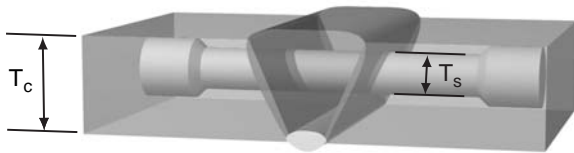
Table 8.3 Transverse Tension Test PQR Data Block

Specimen Number	Width, inch (mm)	Thickness, inch (mm)	Area, inch <sup>2</sup> (mm <sup>2</sup> )	Load, Lb (Kg)	Stress, psi (MPa)	Location
1	0.690 (17.5)	0.250 (6.35)	0.172 (111)	11,000 (5000)	63,900 (440)	WM
2	0.790 (20)	0.220 (5.59)	0.174 (112)	10,100 (4590)	58,000 (400)	BM

When test coupons are over 1 inch (25.4 mm) thick, full thickness specimens may be used per QW-151.1(b) or multiple specimens may be taken at each location per the rules of QW-151.1(c) and (d) (Figure 8.9). In either case, make certain the specimens are prepared in accordance with the applicable paragraph of QW-462.

### Turned Specimens (QW-151.3)

Turned specimen (Figure 8.8) test reports record the diameter of the turned specimen  $T_s$  from which the area is calculated. The turned specimen has a  $\pm 0.010$  inch (0.25 mm) tolerance for a 0.505 inch (12.8 mm) diameter. NOTE: this is not an approximate dimension. Reference QW-462.1(d), where  $D=0.500 \pm 0.010$  inch ( $12.7 \pm 0.25$  mm).



Note: Each process or procedure shall be included in the tension, bend or impact test specimen. Ref. QW-200.4(a)

Figure 8.8 Turned tension specimen, known as a “505”.  
The lighter weld area is the root pass.

Turned specimens QW-462.1(d) (Figure 8.8) are calculated similarly to the flat specimen, except the turned specimen area is calculated by the formula;

Area =  $\pi r^2$  where  $\pi$  is 3.14159 and  $r$  is the radius.

The ultimate tensile strength (UTS) is calculated as follows:

- US Customary formula: UTS in psi = total load in pounds  $\div$  area in square inches.
- SI Units formula: UTS in MPa = total load in Kg  $\div$  area in  $\text{mm}^2 \times 9.81$ .

A standard  $\frac{1}{2}$  inch (12.7 mm) diameter turned specimen has a  $\frac{1}{4}$  inch (6.35 mm) radius. The area =  $\pi \times (0.25 \text{ inch})^2 = 0.196 \text{ inch}^2$  [Area =  $\pi \times (6.35 \text{ mm})^2 = 127 \text{ mm}^2$ ].

A “505” turned specimen was originally developed for the convenience of the Code user. A 0.505-inch (12.8 mm) diameter specimen produced an area of  $0.2 \text{ inch}^2$  ( $129 \text{ mm}^2$ ). The rules permitted Code users to divide the ultimate load in pounds by 0.2 to “calculate” the ultimate tensile stress. The Code still requires the  $\frac{1}{2}$  inch (12.7 mm) test specimen to be machined with a tolerance of  $\pm 0.010$  inch ( $12.7 \text{ mm} \pm 0.25 \text{ mm}$ ). However, QW-152 currently requires these values be computed from the actual measured area (before the load is applied).

**Example 8.8.1** Table 8.1 (QW-451.1), Note (2) refers to QW-200.4(a), second paragraph, which requires weld metal from each process or procedure to be included in the tension, bend, and when required, notch toughness specimens. Figure 8.8 illustrates a root process (lighter root weld metal) and the fill process (darker fill weld metal area). In this case, none of the root process weld metal would have been included in the turned tension test coupon. In such case, a second tension test coupon would have to be welded and tested to assure some of the root process weld metal was included in the tension test. There is no specified amount of weld metal that must be included in the test specimens. Note: This requirement is not limited to turned specimens. See Figures 14.2 and 14.3 for further details on QW-200.4(a), second paragraph.

# Chapter 9

## CHECKLIST FOR WPS AND PQR

This chapter provides the Code user with checklists to document that the WPS and PQR have complied with all of the requirements of Section IX and the applicable Construction Code. The WPS or PQR may be documents prepared by the Code user, or contractual documents that the Code user must review. Each checklist is similar to the tables in QW-250 for each welding process (Table 3.3). Each checklist has had the supplementary essential variables column removed as in Table 6.1. Each checklist has three additional columns, WPS, PQR and QUAL (Tables 9.1 through 9.4).

- The **WPS** column is used to document that the WPS has been properly completed and has addressed all the requirements of Section IX and the construction code.
- The **PQR** column is used to document that the PQR has been properly completed and has addressed all of the requirements of Section IX and the construction code.
- The **QUAL** column is used to document that the values for each essential variable recorded on the PQR properly support the specified range of variables on the WPS.

The checklists in this chapter have been derived from the actual list of variables required for each process in QW-250. The first checklist is for the SMAW process (Table 9.1). Each checklist has been prepared for welding applications where *notch-toughness is not a requirement* of the construction code and therefore the supplementary essential variables are not required. The checklists were prepared with the supplementary essential variables omitted from the checklist. These checklists may be used when notch toughness applications are a requirement of the construction code by adding the supplementary essential variables from QW-250 for the applicable process.

The checklists begin with the identification block, which allows the Code user to list the WPS and supporting PQR, revision level, and date of the reviewed documents. The checklists end with a Documentation Review Certification that allows space for additional comments, and a space to sign and date the review and indicate whom the reviewer is representing. These details are optional, but do provide verifiable, documented evidence of the Code user's review.

The first five columns of Table 9.1 are similar to Table 6.1. The next three columns are headed with WPS, PQR, and QUAL. The variables are listed as NE, for nonessential variables, or E for essential variables.

- The WPS column spaces are all open, since the WPS must describe all essential and nonessential variables (QW-200.1(b)).
- The PQR column spaces are open opposite the essential variables, because the PQR must record all essential variables. The spaces opposite the nonessential variables are shaded, because the PQR is not required to document nonessential variables.
- The QUAL column spaces are open opposite the essential variables, because the QUAL column will record if the essential variables specified on the WPS are properly supported by the value recorded on the PQR. The spaces opposite the nonessential variables are shaded, as the QUAL column does not evaluate nonessential variables.

**Example 9.1.1** It is preferred to briefly record a value for each variable. For example, if a Code user were to review WPS # 134 (Table 5.1), and the variable for QW-403.8 was being reviewed, the Code user could record  $\frac{1}{16}$  inch (1.6 mm) through  $\frac{3}{4}$  inch (19.1 mm) within the space opposite QW-403.8 in the WPS column. When PQR # Q134 (Table 5.2) was being reviewed for the same variable, the Code user could record  $\frac{3}{8}$  inch (9.6 mm) in the space opposite QW-403.8 in the PQR column. The Code user may conclude that  $\frac{1}{16}$  inch (1.6 mm) through  $\frac{3}{4}$  inch (19.1 mm) properly described the variable QW-403.8 on the WPS. The Code user may conclude that  $\frac{3}{8}$  inch (9.6 mm) properly describes the variable QW-403.8 on the PQR. The Code user may then conclude that the value of  $\frac{1}{16}$  inch (1.6 mm) through  $\frac{3}{4}$  inch (19.1 mm) in the WPS column is properly supported by the value of  $\frac{3}{8}$  inch (9.6 mm) in the PQR column, and an OK (or a ☺) may be marked in the QUAL column.

When each space under the WPS and PQR columns has proper entries, the Code user may conclude that the WPS and PQR are properly prepared. If either the WPS or PQR are not properly prepared, if one or more variables are not described or recorded, then the documents must be properly completed for each errant variable. When every variable in both columns is acceptable (properly addressed), and each space in the QUAL column is noted OK (or a ☺), the Code user has a verifiable, documented record of the review.

The nonessential variables must be evaluated against the details defined in QW-402 through QW-410 for each process. The Code user can record a value, such as QW-405.1 Positions, for WPS # 134 (Table 5.1), as “All” in the space opposite QW-405.1 under the WPS column. The Code user may check the type of electrodes that have been specified, conclude that both electrodes may be used in all positions, and therefore accept all positions on the WPS for this variable. The Code user may list “All” in the space opposite QW-405.1 under the WPS space, or simply note “OK” (or a ☺), in that same space. The preferred entry is a value that will provide the most information for future reference.

Verifying some of the entries may be difficult. For example, QW-402.4 and QW-402.11 may both be covered by a single entry such as “no backing.” QW-403.7 and QW-403.8 both address base metal thickness. A single entry in the WPS column, as in WPS # 134 (Table 5.1),  $\frac{1}{16}$  inch (1.6 mm) through  $\frac{3}{4}$  inch (19.1 mm) actually covers both variables. Or the Code user could note opposite QW-403.7 that the variable was not applicable for this application, since QW-403.7 only applies when the PQR test coupon is  $1\frac{1}{2}$  inch (38.1 mm) thick or thicker. QW-403.11 and QW-403.13 may also be satisfied with a single entry, as in WPS # 134 (Table 5.1), P-Number 1 to P-Number 1 covers both variables. Or the Code user could note that QW-403.13 is not applicable since it only applies to documents using P-Numbers 5, 9, or 10.

These checklists are provided as a convenience and may be used or revised in any manner that helps the Code user. Or the checklist may not be required at all.

Page 2 of the checklist covers some requirements that are not variables. One such variable is QW-401, which clearly states that each essential variable has been listed in QW-250 for each specific process. The paragraph ends by stating, “A change in a process is an essential variable change.” As such, these checklists provide a space to document the type of process at the top of page 2.

QW-202.2 has some special rules for fillet welds and partial penetration groove welds, so it is important to document that all these rules have been properly applied to the WPS and PQR. This is a good reminder to document the rules of QW-202.2, QW-202.3, and QW-202.4.

QW-200.4 has some special requirements for combination WPSs. Section IX has referred to a change in a “procedure” (non-standard term) as any change in an essential variable. This is a good reminder to document the rules of QW-200.4 if the Code user has a combination procedure.

QW-451.1 reminds the Code user to document the proper number of bend and tension tests, and there is a space to record the results.

QW-404.5 reminds the Code user to document an important requirement, that is, the basis for assigning the A-Number on the two documents.

QW-170 reminds the Code user to document if notch-toughness was required by the construction code.

There is space to document any company, customer, or contractual requirements.

QW-201 reminds the Code user that the PQR must be certified by a company representative.

Table 9.1 Shielded Metal-Arc Welding (SMAW) Checklist.

Review of WPS #		Revision #			Dated:	
Supporting PQR(s) #		Revision #			Dated:	
Paragraph	Brief of Variables	Ess	Non	WPS	PQR	QUAL
QW-402 Joints	.1	φ Groove design		NE		
	.4	- Backing		NE		
	.10	φ Root spacing		NE		
	.11	± Retainers		NE		
QW-403 Base Metals	.7	T/t limits > 8 inch (203 mm)	E			
	.8	φ T qualified	E			
	.9	t Pass > ½ inch (13 mm)	E			
	.11	φ P-No. qualified	E			
	.13	φ P-No. 5/9/10	E			
QW-404 Filler Metals	.4	φ F-Number	E			
	.5	φ A-Number	E			
	.6	φ Diameter		NE		
	.30	φ t	E			
	.33	φ AWS class		NE		
QW-405 Positions	.1	+ Position		NE		
	.3	φ ↑↓Vertical welding		NE		
QW-406 Preheat	.1	Decrease > 100°F (Δ56°F)	E			
	.2	φ Preheat maintenance		NE		
QW-407 PWHT	.1	φ PWHT	E			
	.4	T limits	E			
QW-409 Electric	.4	φ Current or polarity		NE		
	.8	φ I & E range		NE		
QW-410 Tech	.1	φ String/Weave		NE		
	.5	φ Method cleaning		NE		
	.6	φ Method back gouge		NE		
	.9	φ Multi to single pass/side				
	.25	φ Manual or automatic		NE		
	.26	± Peening		NE		

Table 9.5 is a sample checklist, which has been prepared to demonstrate how a Code user can use the checklists in this chapter to evaluate the Company Inc. WPS CS-1 and PQR CS-1. The following text will identify a marker, a number in a circle such as ① which may be found on the sample WPS CS-1 (Figure 9.1), on the sample PQR (Figure 9.2), and again on the sample SMAW Checklist (Table 9.5) for Company Inc. The circled number is then used in “The Narrative” to explain each of these entries. The Narrative begins at the end of Table 9.5. This circled marker number may occur in more than one place, as necessary, to locate where a given variable or entry may be found. Each reviewer may use these checklists in any manner to suit their needs.

**Example 9.1.1** A Code user may use the checklist to review the WPS to make certain the WPS has a value specified for each variable. At that time, the Code user should document if the value specified is a correct value for the variable. For example, at marker ⑭ in Table 9.5, the WPS specified an SFA-5.1 specification, AWS E7010 classification. An entry was made to fulfill the requirement of the variable QW-404.33. But the entry has two errors.

- First error: SFA-5.1, the specification for carbon steel covered electrodes does not have an E7010 classification.
- Second error: If the Code user checks SFA-5.5, the specification for low alloy steel covered electrodes, where the E70XX should be found; the reviewer will not find the E7010 classification. The AWS mandatory classification designator of -A1 is required for the proper classification of AWS A5.5 Classification E7010-A1 (See Table 14.2 and 15.1 for more details on classification).
- Resolution: The Code user may stop and correct these errors immediately if the document is in preparation, or a non-conformity report may be prepared by the reviewer for action by the person responsible for the preparation of the WPS. In any case, the checklist may be used to document these errors and possibly be used as the non-conformity report.

**Example 9.1.2** When the WPS has a proper entry for each variable, then use the checklist to ensure the PQR has a value recorded for each variable, again checking that the value recorded is the correct value for the variable. For example, at marker ⑳ in Table 9.5, the PQR recorded a value of A-Number 2. An entry was made to fulfill the requirement of the variable QW-404.5. But the entry has an error.

- Error: An AWS E7018 filler metal, recorded as the electrode used to weld the PQR test coupon, is not an A-Number 2 analysis. It is not an A-Number 2 analysis by a weld analysis, or by the SFA-5.1 AWS E7018 classification analysis, nor the manufacturer’s published literature. An AWS E7018 electrode normally produces an A-Number 1 weld analysis (see Table 4.11 & 4.12).
- Resolution: The Code user may stop and revise these errors immediately if the document is in preparation, or a non-conformity report may be prepared by the reviewer for the person responsible for the preparation of the WPS. In any case, the checklist may be used to document this error and possibly be used as the non-conformity report.

When the Code user has verified that both documents are properly prepared, the checklist may be used to document if each essential variable recorded on the PQR supports the range specified on the WPS.

Table 9.5 has been prepared to demonstrate this checklist system against a mythical WPS CS-1 (Figure 9.1) and PQR CS-1 (Figure 9.2) prepared by Company Inc. on the ASME sample forms, QW-482 (Figure 2.1) and QW-483 (Figure 2.2). WPS CS-1 and PQR CS-1 are typical forms used by small fabricators or repair firms. At times, the client or jurisdiction demands the use of the ASME suggested forms found in Section IX, non-mandatory Appendix B. These forms are typical of limited information,

typed into the proper space on the forms. These forms are intended to provide examples typical of the documentation Code users are likely to encounter.

A Code user may also review the WPS CS-1 or PQR CS-1 for a specific entry, for example, PWHT on WPS CS-1. The Code user would find PWHT on WPS CS-1 (page 2) and markers ①<sup>9</sup>, ②<sup>0</sup> at that entry. The Code user may then find ①<sup>9</sup> and ②<sup>0</sup> on the checklist (Table 9.5) under the WPS column and find “NA ⊕,” indicating that the entry on WPS CS-1, at the PWHT box, which was “NA,” may not be an appropriate entry as indicated by the “⊕.” The Code user may then look for the markers ①<sup>9</sup>, ②<sup>0</sup> in the narrative to review the explanation of how to handle that specific entry. This may help the Code user who may only need a few pointers in a specific area. This exercise is not intended, however, to encourage the Code user to simply fill in the forms.

When the full checklist (Table 9.5) uses all the markers ① through 60, the Code user may discover something about the welding documentation. But equally important, the Code user may see many blank areas on the WPS or PQR that have not been addressed. If it is not on the checklist, the variable or entry may apply to another process or application. For example, there are no electrical (QW-409) nor technique (QW-410) variables listed on the PQR. Did the checklist miss these variables? No, there are no essential variables for the SMAW process in either the QW-409 nor QW-410 variables. But the sample forms in Section IX, Nonmandatory Appendix B have spaces for all variables for four processes (specifically SMAW, GMAW, GTAW and SAW), which will result in blank spaces even when all the variables for a specific process have been addressed. The checklist can be used to assure the Code user that the documentation under review has had every required variable addressed.

**QW-482 SUGGESTED FORMAT FOR WELDING PROCEDURE SPECIFICATIONS (WPS)**  
 (See QW-200.1, Section IX, ASME Boiler and Pressure Vessel Code)

Company Name: Company Inc. By: Pea Green  
 Welding Procedure Specification No.: CS-1 Date: 01Aug87 Supporting PQR No.(s): CS-1  
 Revision No. \_\_\_\_\_ Date: \_\_\_\_\_  
 Welding Process(es): SMAW 28 Type(s): Manual 26  
 (Automatic, Manual, Machine, or Semi-Auto)

JOINTS (QW-402) Details 3

Joint Design: Single V, double V, J & U 1  
 Backing (Yes): √ 2 (No): √ 2  
 Backing Material (Type): weld metal 2  
 (Refer to both backing and retainers.)

Metal 4  Nonfusing Metal  
 Nonmetallic  Other

Sketches, Production Drawings, Weld Symbols or Written Description should show the general arrangement of the parts to be welded. Where applicable, the root spacing and the details of weld groove may be specified.

(At the option of the Mfgr., sketches may be attached to illustrate joint design, weld layers and bead sequence, e.g. for notch toughness procedures, for multiple process procedures, etc.)

---

\*BASE METALS (QW-403)

P-No.: 1 8 9 Group No.: \_\_\_\_\_ to P-No.: 1 8 9 Group No.: \_\_\_\_\_  
 OR  
 Specification type and grade: \_\_\_\_\_  
 to Specification type and grade: \_\_\_\_\_  
 OR  
 Chem. Analysis and Mech. Prop.: \_\_\_\_\_  
 to Chem. Analysis and Mech. Prop.: \_\_\_\_\_  
 Thickness Range \_\_\_\_\_

Base Metal: \_\_\_\_\_ Groove: 1/16 in. through 3/4 in. 5 6 29 Fillet: \_\_\_\_\_  
 Pipe Dia. Range: \_\_\_\_\_ Groove: 1 in. min. OD Fillet: \_\_\_\_\_  
 Other: 7 30 31 32

---

\*FILLER METALS (QW-404)

Spec. No. (SFA): 5.1 14  
 AWS No. (Class): E7010 14  
 F-No.: 3 10  
 A-No.: 2 11  
 Size of Filler Metals: 3/32, 1/8, 5/32 in. 12  
 Weld Metal  
 Thickness Range \_\_\_\_\_  
 Groove: 3/4 in. max. 13  
 Fillet: \_\_\_\_\_  
 Electrode-Flux (Class): \_\_\_\_\_  
 Flux Trade Name: \_\_\_\_\_  
 Consumable Insert: \_\_\_\_\_  
 Other: \_\_\_\_\_

\*Each base metal-filler metal combination should be recorded individually.

Figure 9.1 WPS # CS-1 Page 1 of 2



Table 9.5 (Example 9.5.1) Shielded Metal-Arc Welding (SMAW) Checklist (Continued).

Review of WPS #		Company Inc CS-1		Revision # -0-		Dated: 01Aug87	
Supporting PQR(s) #		CS-1		Revision # -0-		Dated: 01Aug87	
Paragraph		Brief of Variable	Description	WPS	PQR		QUAL
QW-401	28	Process	SMAW	√ ☺	43	√ ☺	☺
QW-202.2	29	Groove and Fillet	Groove welds	√ ☺	44	? ☺	☺
QW-202.3	30	Repairs Buildup	Not specified		45	☺	☺
QW-202.4	31	Dissimilar Base T <sub>b</sub>	Not applicable		45	☺	☺
QW-200.4	32	Combination procedures	QW-200.4(a) provisions only		45	☺	☺
Requirement		Description			PQR		
QW-451.1	Bend Tests	Four bend tests per QW-160.			48	2 side bends. ☺	
	Results	One clear, one with 3/32 in. opening. ☺			49	Results ☺/☺ (48).	
QW-451.1	Tension Tests	Two tension tests per QW-150.			46	2 tension tests. ☺/☺	
	Results	72,325 psi, 74,650 psi ☺.			47	Need 60 ksi. ☺	
QW-404.5	A-Number	Basis for A-No.?			50	?	
QW-170	Notch-toughness	Required by construction Code?			51	Not required.	
	Company requirements?	No Company requirements.			52		
	Contract requirements?	No Contract requirements.			53		
	Other requirements?	No Other requirements.			54		
QW-201	Certification	Company representative & date.			55	Pea Green. ☺	
Documentation Review Certification							
Reviewer comments:							
WPS incomplete. Cannot evaluate until markers 3, 7, 18, 19, 20, 24, 27 & 60 are completed and 14 is corrected.							
PQR incomplete. Cannot evaluate until: marker 48 has recorded four bends, marker 46 has the test coupon mystery solved & marker 38 has been corrected.							
When the problems with the WPS and PQR noted in the comments above have been resolved, the following PQR variables do not support the WPS specified ranges as detailed below:							
Marker 35 P-No. 4, does not support the value specified at marker 8 P-No. 1.							
Marker 37 F-No. 4, does not support the value specified at marker 10 F-No. 3.							
Marker 39 200°F, does not support the value specified at marker 17 50°F.							
Marker 40 1150°F PWHT, does not support the value specified a marker 19, no PWHT.							
These documents reviewed by: Per MacSquinity 56					Date: 01Aug87		
Reviewer representing: Company Inc. 57							

**Narrative**

A Code user may start with the identification block at the top of both pages of Table 9.5 (SMAW Checklist) to provide a record of the exact documentation being reviewed. A review of the values specified or recorded at each marker is discussed below.

The following notes are referenced to the marker (bracketed) numbers on the sample documentation of (Figures 9.1 and 9.2). These same marker numbers are referenced on the sample checklist (Table 9.5) for convenience in locating each area where the apparent non-conformity appeared in this total example 9.5.1.

**WPS Audit Checklist**

① On WPS CS-1, Company Inc. listed “Single V, double V, J & U” grooves to meet the requirements of QW-402.1. In table 9.5, the reviewer listed V, X, J & U as a key to what was on the WPS. QW-402.1 deals with type of joint and, in the reviewer’s opinion, this entry addressed the groove design as required by QW-402.1. The reviewer also believed the entry was proper and adequate. The reviewer then affixed a ☺, indicating that an entry had been made which addressed QW-402.1, that the entry was do-able, and conformed to the requirements of the Code.

② The subject of variable QW-402.4 is backing. The WPS specified “Yes and No,” which the reviewer accepted as addressing QW-402.4. The reviewer therefore noted “yes and no” in the WPS column and a ☺, indicating the variable had been addressed, and the entry was acceptable. The Code user specified, “weld metal” as the backing material (type). This is not a required entry, as the E6010 is obviously the backing for the subsequent E7018 layers. But it is always acceptable, and often prudent to add information beyond that required by the Code.

③ The reviewer could not find an entry that addressed QW-402.10, so therefore noted “not specified” in the WPS column and a ☹, indicating the WPS is not complete. QW-402.10 must be addressed on the WPS to properly complete the WPS so it may be evaluated against the supporting PQR.

④ The Nonmetallic and Nonfusing Metal boxes were not checked, indicating, that neither backing type has been specified.

**Note:** Since neither backing type was specified, neither backing type may be used unless the WPS is revised to include one or more of these backing types. This entry in the WPS column received a ☺ of approval.

⑤ The reviewer read QW-403.7 and found this variable applied only when the PQR test coupon was 1½ inches (38.1 mm) thick or thicker. A quick check of PQR CS-1 revealed a ⅜ inch (9.6 mm) PQR test coupon was used, and therefore QW-403.7 was not applicable for these documents. The reviewer noted not applicable in the WPS column and crosshatched the spaces under PQR & QUAL on that line, since the variable was not applicable.

⑥ The reviewer noted ⅛ - ¼ inch (1.6 – 19.1mm) in the WPS column and a ☺ of approval.

⑦ The reviewer noted the thickness of each pass was “not specified ☹.” See Figure 7.20 and Table 7.13 for details. QW-403.9 must be specified to bring WPS CS-1 into conformance with Section IX.

**Note:** The reviewer should continue through each variable on the list, regardless if it is an essential or a nonessential variable, simply reviewing the subject of each variable and making certain an appropriate value for each variable was recorded on the WPS. It will be after the WPS and the PQR are both validated as complete, that the PQR will then be evaluated to determine if the values specified on the WPS are supported by the values recorded on the PQR.

⑧ P-No. 1 to P-No. 1 ☺. This is an acceptable entry for the P-Number.

⑨ Not applicable. Marker ⑧ indicates this WPS covers P-No. 1 and, therefore, QW-403.13, which only deals with P-Numbers 5, 9, and 10, is not applicable. The reviewer so noted Not applicable in the WPS column and crosshatched the spaces under PQR & QUAL on that line, since the variable was not applicable.

# Chapter 10

## ***HOW TO PREPARE AND REVIEW A WPQ***

This chapter provides the Code user with detailed instructions for preparing and reviewing a welder performance qualification (WPQ), to assure that the WPS is properly written, that the tests and test results are satisfactory, and that the tests have properly supported the variable ranges specified on the WPQ.

The following is a brief overview of the steps involved in preparing or reviewing a WPQ.

- Review QW-350 for the essential variables which must be qualified and recorded for each process.
- Determine what applications the welders will be required to weld in conjunction with the essential variables listed by process in QW-350.
- A Code user must supervise the welding of the performance qualification test coupon.
- The performance qualification test coupon must be welded following the direction of a qualified WPS (unless the welder is simultaneously welding the PQR test coupon to qualify the WPS).
- The welded test coupon must be examined by radiography (depending on the process used) or examined visually and then cut into specimens to be mechanically tested.
- The actual value of each essential variable, the tests conducted, the test results, and the ranges qualified for each essential variable must be documented on a WPQ form.
- The Code user prepares a new WPQ for the performance qualification of each welder for each change of essential variable of QW-350 for each process.
- A reviewer verifies that a WPQ properly supports the qualified ranges of the welding variables used by each welder for each process as specified in QW-350.

**Caution:** There may be other performance variables imposed by the code of construction, the client or the jurisdiction.

Table 10.1 (QW-353) lists the essential variables required for the performance qualification of a welder using the SMAW process. Each welder must weld a performance qualification test coupon and the Code user must record the actual value on a WPQ for each of these essential variables. The ranges qualified for these essential variables must also be specified on the WPQ. Sample form QW-484 (Figure 2.3) has two columns, one for the actual variables and the second for the ranges qualified. In addition to the essential variables, there are examination results and test results which must be recorded on the WPQ form.

Each variable is interdependent upon the other variables. For example, when qualifying for a change in QW-403.16, the pipe diameter variable, the Code assumes each of the other variables; specifically, the weld metal thickness, backing, F-Number, P-Number, position and progression remain the same. Multiple process welder performance qualifications may be documented on a single WPQ form. The suggested forms in Section IX, Non-Mandatory Appendix B, however, provide very little space for multiple process documentation. [Interpretation IX-89-03, question 3, covers multiple processes recorded on a single WPQ.]

WPQ # 342 (Table 5.3) is noted at the end of each section in this chapter to demonstrate how the sample WPQ was documented.

Table 10.1 QW-353 Shielded Metal-Arc Welding (SMAW) Essential Variables

Paragraph		Brief of Variables
QW-402 Joints	.4	- Backing
QW-403 Base Metals	.16	φ Pipe diameter
	.18	φ P-Number
QW-404 Filler Metals	.15	φ F-Number limits
	.30	φ t Weld metal deposit
QW-405 Positions	.1	+ Position
	.3	φ ↑↓ Vertical welding

This chapter explains how to apply each of these welder performance qualification essential variables. As with chapters 6 and 7, this chapter will use the group of variables as the heading of each section to remind the Code user of the source of the variable under discussion. For example, see Table 10.2 which relates to QW-403.18, the first variable to be explained in this chapter.

### QW-403 Base Metal, P-Numbers

Table 10.2 QW-403.18, P-Numbers

QW-353 Shielded Metal Arc Welding (SMAW) - Essential Variables		
Paragraph		Brief of Variables
QW-403 Base Metals	.16	φ Pipe diameter
	.18	φ P-Number

QW-403.18 A change from one P-Number to any other P-Number or to a base metal not listed in QW/QB-422 except as permitted in QW-423, and in QW-420.2

Paragraph QW-403.18 allows QW-423 to be used as an alternate for the base materials P-Numbers qualified for the welder performance qualification (WPQ) ranges.

QW-423.1 Base materials used for welder qualification may be substituted for the P-Number material specified in the WPS in accordance with the following.

Table 10.3 QW-423.1 Alternate Base Metals for Performance Qualification

Base Metal(s) for Welder Qualification	Qualified Production Base Metal(s)
In this column is the list of base metals which a welder may use for the welder performance qualification (WPQ) test coupon. The P-Number used is recorded on the WPQ.	The WPQ may then specify that the welder is qualified to weld on the base metals listed below.
When the welder uses a P-Number listed below: P-No. 1 through P-No. 11, P-No. 34 or P-No. 41 through 47	The WPQ may list all of the P-Numbers below: P-No. 1 through P-No. 11, P-No. 34, or P-No. 41 through 47 and unassigned metals of similar chemical composition to these metals.
P-No. 21 through P-No. 25	P-No. 21 through P-No. 25
P-No. 51 through 53 or P-No. 61 and 62	P-No. 51 through 53 and P-No. 61 and 62

**Example 10.3.1** Table 10.3 (QW-423.1) shows the liberal range of base metals qualified by a welder performance qualification test. Peat Bog, the welder in sample WPQ # 342 (Table 5.3), welded using an ASME SA-106 Grade B pipe, a P-Number 1 WPQ test coupon. P-Number 1 is listed within the metals of the first column, first row of QW-423.1, specifically, P-Number 1 through P-Number 11, P-Number 34 or P-Number 41 through 47. Based on QW-403.18 and the referenced QW-423, Peat Bog is qualified to weld all P-Number 1 through P-Number 11, P-Number 34, P-Number 41 through 47, and unassigned metals of similar chemical composition to these metals.

Chapters 6 and 7, however, detail the requirement for a WPS properly supported by a PQR to be used for all Code welding applications. Therefore, in order for Peat Bog to weld on all these base metals, the Code user must have properly qualified WPSs for each application. Peat Bog may weld on each of the base metals within the range from P-Number 1 through P-Number 11, P-Number 34, and P-Number 41 through 47, but only as the Code user has properly qualified WPSs for those base metals. [Interpretations IX-86-51 and IX-89-15 cover this P-Number 1 through P-Number 11, P-Number 34 and P-Number 41 through 47 rule.]

Peat Bog is governed by all other essential variables listed for the process in QW-353 (Table 10.1). In this example, Peat Bog would be qualified to weld on all those base metals, provided F-Number, backing, pipe diameter, weld metal thicknesses, positions, and progression qualifications remain as shown in the column “Actual Ranges Qualified.”

Within QW-423.1 (Table 10.3) are unassigned metals of similar chemical composition to the P-Number metals in the same block. Chapters 6 and 7 detailed how each of these unassigned base metals requires individual PQR support. But, for the purpose of welder’s qualification, as long as the base metals are similar in weldability, the welder does not have to qualify for each unassigned base metal individually. Section IX assumes that a welder will be able to produce sound welds on plain carbon steels, Mn-Mo steels, and Cr-Mo steels equally well, and that the welder will not use different techniques, from one type of metal to another. Therefore, QW-423.1 (Table 10.3) extends its liberal base metal policy to include unassigned base metals of similar composition.

Some Code users do not wish to take advantage of these rules. Some utility and petrochemical organizations require welders to be qualified for welding pipe by using a P-Number 5A base metal with an AWS Specification A5.5 Classification E9018-B3 filler metal. Their experience has shown that this combination is more difficult for a welder to use than welding a plain carbon, P-Number 1, steel with an AWS Specification A5.1 Classification E7018 filler metal. This is an example of a Code user going beyond the minimum requirements of the Code.

S-Numbers, addressed in QW-420.2, a listing of materials acceptable for use by the ASME B31 codes or by ASME code cases, are not included within the material specifications (ASME Section II). S-Number groupings are similar to P-Number groupings. For performance qualification, the requirement for base metal P-Numbers shall also apply to the same S-Numbers. Qualification with P-Numbers in accordance with QW-403.18 applies to corresponding S-Numbers and vice versa. This means that QW-423.1 (Table 10.3) could read: P-Number 1 through 11, P-Number 34 or P-Number 41 through 47 and S-Number 1 through 11, S-Number 34 and S-Number 41 through 47, qualify for P-Number 1 through 11, P-Number 34, P-Number 41 through 47, and S-Number 1 through 11, S-Number 34, S-Number 41 through 47 and unassigned metals of similar chemical composition to these metals.

Another feature of QW-420.2 is that base metals of different material specifications, with the same UNS number as an S-Number base metal, shall be considered that S-Number. See Table 4.7 and associated text for more details about UNS numbers.

In summary, WPQs with P-Numbers in accordance with QW403.18 qualify for corresponding S-Numbers, and vice versa. **Reminder Note:** The vice versa is not allowed for procedure qualification.

Table 10.4 QW-403.18, P-Numbers, S-Numbers, and Unassigned Metals

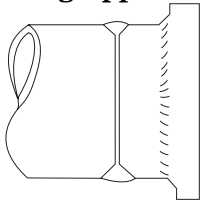
<b>Welding Application</b>  Figure 10.1	<b>WPS</b> Specify: Variable ranges Essential variables Nonessential var. Other directions	<b>PQR</b> Record: Actual values Essential variables Tests and results Other data	<b>WPQ</b> Record: value tested Specify: range qualified Record type of tests and results	
		QW-253 lists QW-403.11 which requires base metals in the WPS to be qualified using PQR base metals per QW-424.	QW-353 lists QW-403.18 as an essential variable for the welder performance qualification WPQ.	
<b>Example 10.4.1:</b> SA-199 T11 P-No. 4 base metal.	QW-403.11 List: P-No. 4 on the WPS.	QW-403.11 Weld test coupon T <sub>c</sub> using P-No. 4 base.	Welder may use P-No. 1 base metal test coupon.	Range qualified P-No. 1 through 11, P-No. 34 and P-No. 41 through 47 & similar.
<b>Example 10.4.2:</b> A-106 Gr. B to A-182 Gr. F1 (P-No. 1 to P-No. 3) with E7010 (F-No. 3).	QW-403.11 List: P-No. 3 to P-No. 1 using E7010 (F-No. 3).	QW-403.11 Use A 182 Gr. F1 (P-No. 3) with E7010 (F-No. 3).	Use SA-106 Gr. B (P-No. 1) using E6010 (F-No. 3).	With F-No. 3 range qualified actually, for P-No. 1 & P-No. 3 only.
<b>Example 10.4.3:</b> SA-182 Gr. F21, (P-No. 5A) using E9018 B3 (F-No. 4).	QW-403.11 List: P-No. 5A using E9018-B3 (F-No. 4).	QW-403.11 Use SA-335 Gr. P22 (P-No. 5A) with E9018-B3.	Use SA-106 Gr. B (P-No. 1) using E7018 (F-No. 4).	With F-No. 4 range qualified actually for P-No. 1 through P-No. 5 only.
<b>Example 10.4.4:</b> SA-312 Type 304 (P-No. 8) using E308Cb-16 (F-No. 5).	QW-403.11 List: P-No. 8 using E3XX-16 (F-No. 5).	QW-403.11 Use SA-312 Type 304 (P-No. 8) with E308-16.	Use SA-106 Gr. B (P-No. 1) using E308-16 (F-No. 5).	With F-No. 5 range qualified actually P-No. 1 through P-No. 11 only.
QW-420.2 Allows P-Numbers to qualify for S-Numbers. The WPS & PQR S-Numbers do not qualify for P-Numbers. The WPQ S-Number, however, qualify for P-Numbers.				
<b>Example 10.4.5:</b> A 269 Type 317 (No P-No.), (No S-No.) but may assume S-No. 8 based on UNS No. S31700 for both A 269 Type 317 & SA-312 Type 317.	QW-403.11 list: (No P-No.) A 269 Type 317 only (may specify S-No. 8) as allowed in QW-420.2.	QW-403.11 (No P-No.) use A 269 Type 317 (May record S-No. 8) as allowed in QW-420.2 (considered unassigned).	Use SA-106 Gr. B (P-No. 1) using E309-16 (F-No. 5).	With F-No. 5, P-No. 1 through P-No. 11, S-No. 1 through S-11 and A 269 Type 317 (assigned S-No. 8) as allowed in QW-420.2.
<b>Example 10.4.6:</b> Same as 10.4.5 but all S-No. 8 and A 269 Type 317.	QW-403.11 list: S-No. 8 & A 269 Type 317.	QW-403.11 (No P-No.) use A 269 Type 316 (S-No. 8).	Use SA-106 Gr. B (P-No. 1) using E309-16 (F-No. 5).	Welder qualified the same as example 10.4.5.
WPQ # 342 (Table 5.3).			P-No. 1 to P-No. 1.	P-No. 1 through 11, P-No. 34 and P-No. 41 though 47.

Table 10.4 covers six applications which will help define the use of P-Numbers, S-Numbers and unassigned metals. These examples define a specific application, and then briefly cover what is required

of the WPS and PQR for comparison, but the emphasis is primarily on the WPQ. This table covers only the base metal essential variables.

**Example 10.4.1** The welding application in Figure 10.1 is a P-Number 4 base metal. The Welder may use a P-Number 1 base metal as the WPQ test coupon, which will qualify the welder for all P-Number 1 through P-Number 11, P-Number 34 and P-Number 41 through 47 metals, and all S-Number 1 through S-Number 11, S-Number 34 and S-Number 41 through 47 metals as allowed by QW-420.2 and QW-423 (see Example 10.4.5).

Although this is the full range allowed by the Code, it is not practical to expect a single qualification to cover all of these applications. For example, a Code user would not prepare a WPS, to weld using an F-Number 3 filler metal to weld on P-Number 8 base metals (austenitic stainless steels). Some of the ENiCrFe-XX series of filler metals may be able to cover the full range of base metals as allowed by QW-423, but they were not intended to allow an E6010, F-Number 3 filler metal to weld on that full range of base metals. Examples 10.4.2, 10.4.3, and 10.4.4 review some applications wherein the Code user chose to assign a more practical or reasonable range of base metals for which the welder is qualified.

**Example 10.4.2** The welding application is a P-Number 1 to a P-Number 3 base metal. The Code user chose an ASME SA-106 Gr. B (P-Number 1) carbon steel pipe as the test coupon. The welder used an AWS A5.1 E6010 electrode an F-Number 3 filler metal. The Code user specified the welder's base metal qualification range with the F- Number 3 filler metal to cover P-Number 1 and P-Number 3 base metals only. The Code user does not expect to develop a WPS using a F-Number 3 filler metal to weld metals from any other P-Number groups of base metals. This is how a Code user may sensibly limit the WPQ.

**Example 10.4.3** The welding application is a P-Number 5A base metal welded with a F-Number 4 filler metal. The Code user selected the ASME SA-106 Gr. B pipe again, but with an AWS A5.1 E7018 (F-Number 4) filler metal. The Code user specified on the WPQ that this welder was qualified for P-Number 1 through P-Number 5 base metals.

**Example 10.4.4** The welding application is a P-Number 8 base metal welded with a F-Number 5 filler metal. The Code user used the ASME SA-106 Gr. B pipe again, but with an AWS A5.4 E308-16 (F-Number 5) filler metal. The Code user specified on the WPQ that this welder was qualified for P-Number 1 through P-Number 11 base metals. The Code user may eventually have applications with this range of base metals, and some of the F-Number 5 filler metals are capable of welding this full range of base metals. The only filler metals normally used to weld the P-Number 1 through P-Number 11, P-Number 34 and P-Number 41 through 47 are the F-Number 4X series nickel-base filler metals. A welder qualified with a F-Number 4X filler metal could have the full range of base metals allowed by QW-423 specified on the WPQ.

**Example 10.4.5** The application is ASTM A 269 Type 317, a base metal without a P-Number or S-Number. But this material may be assigned an S-Number 8, as allowed by QW-420.2, since it has the same UNS number, S31700, as ASME SA-312 Type 317. The Code user may prepare a WPS for the ASTM A 269 Type 317 exclusively, and still specify the material as an S-Number 8 for the purpose of welder performance qualification. QW-420 requires the PQR to be an S-Number listed in QW/QB-422 (Table 4.5) in order to establish an acceptance minimum tension test as required by QW-153. As such, the ASTM A 269 Type 317 is considered an unassigned base metal and, according to QW-424, a PQR welded with an unassigned base metal will support a WPS for use with that unassigned base metal only. The Code user selected the ASME SA-106 Gr. B pipe again for the WPQ test, but with an AWS A5.4 E309-16 (F-Number 5) filler metal, and specified on the WPQ that this welder was qualified with an F-Number 5 filler metal, for all P-Number 1 through P-Number 11 and S-Number 1 through S-Number 11. This covered ASTM A 269 Type 317 since it was an unassigned base metal with a chemistry similar to the S-Number 8 base metals. In fact, ASTM A 269 Type 317 was actually certified as an S-Number 8 base metal, as allowed by QW-420.2, because it has the same UNS number as an S-Number 8 base metal.

**Example 10.4.6**, is the same application as 10.4.5, but has been expanded to include all S-Number 8 base metals. This was accomplished by using an ASTM A 269 Type 316, which is included in QW/QB-422 as an S-Number 8 base metal which qualifies for all S-Number 8. The welder qualified in Example 10.4.5 will also be qualified for the application of Example 10.4.6.

### QW-404 Filler Metal, F-Numbers

Table 10.5 QW-404.15, F-Numbers

QW-353 Shielded Metal Arc Welding (SMAW)		
Paragraph	Brief of Variables	
QW-404 Filler Metals	.15	φ F-Number limits
	.30	φ t Weld metal

QW-404.15 A change from one F-Number in QW-432 to any other F-Number or to any other filler metal, except as permitted in QW-433.

See QW-432 – F-Numbers and in Table 4.10 of this Guide for a review of F-Numbers.

Table 10.6 (QW-433) identifies the “qualified with” F-Number, and the “qualified for” F-Numbers the welders may use.



Table 10.6 QW-433, Alternate F-Numbers for Welder Performance Qualification

Qualified with:→ Qualified for:↓	F-1 with backing	F-1 no backing	F-2 with backing	F-2 no backing	F-3 with backing	F-3 no backing	F-4 with backing	F-4 no backing	F-5 with backing	F-5 no backing
F-No. 1 with	X	X	X	X	X	X	X	X	X	X
F-No. 1 without		X								
F-No. 2 with			X	X	X	X	X	X		
F-No. 2 without				X						
F-No. 3 with					X	X	X	X		
F-No. 3 without						X				
F-No. 4 with							X	X		
F-No. 4 without								X		
F-No. 5 with									X	X
F-No. 5 without										X
<b>Qualified With</b>					<b>Qualified For</b>					
Any F-No. 6.					All F-No. 6 (Note 1).					
Any F-No. 21 through F-No. 25.					All F-No. 21 through F-No. 25.					
Any F-No. 31, 32, 33, 35, 36, 37.					Only the same F-No. as was used in the WPQ.					
Any F-No. 34, or any F-No. 41 through F-No. 45.					F-No. 34 and all F-No. 41 through F-No. 45.					
Any F-No. 51 through F-No. 54.					All F-No. 51 through F-No. 54.					
Any F-No. 61.					All F-No. 61.					
Any F-No. 71 through F-No. 72.					Only the same F-No. as was used in the WPQ.					
Note (1): Weld metal made using a bare rod not covered by an SFA Specification, but which conforms to an analysis listed in QW-442, shall be considered to be classified as F-Number 6.										



**Example 10.22.3**, could have been qualified using two welders on the single test coupon, one for the E6010 root and a second for the E7018 fill. Example 10.22.3 could also have been qualified using two separate WPQ test coupons, with the same or separate welders. For example, 10.22.3 could have been qualified using the welder from Example 10.22.2 for the F-Number 3 open root and by using the welder from Example 10.22.1 for the F-Number 4 fill passes.

Table 10.22 QW-402.4, Deletion of Backing

<b>Welding Application</b> E6010 (F3) open root (no backing)  E7018 (F4) fill (using the E6010 as backing)  Figure 10.22	<b>WPS</b> Specify: Variable ranges Essential variables Nonessential var. Other directions	<b>PQR</b> Record: Actual values Essential variables Tests and results Other data	<b>WPQ</b> Record:                      Specify: value                              range tested                              qualified Record type of tests and results	
	QW-253 lists QW-402.4 as a nonessential variable for the WPS.		QW-353 lists QW-402.4 is an essential variable for the WPQ.	
QW-402.4 The deletion of backing in single-welded groove welds. Double-welded groove welds are considered welds with backing.				
<b>Example: 10.22.1</b> Application requires double welding with backgouging using E7018 (F-No. 4).	WPS specify: type of backgouging & backing & F-No. 4 filler metals.	QW-402.4 is not an essential variable for the procedure qualification and therefore open root	Shall weld WPQ with E7018 double-welded or with backing.	Range qualified: welding with backing, fillets, repairs, etc.
<b>Example: 10.22.2</b> Application requires welding with an E6010 (F-No. 3) open root.	WPS must specify: E6010 (F-No. 3) open root, no backing.	versus backing does not affect the PQR.	Shall weld test coupon using E6010 (F-No. 3) open root (no back).	Range qualified: F-No. 3 with backing and without backing.
<b>Example: 10.22.3</b> Application requires welding with E6010 (F-No. 3) open root and with E7018 (F-No. 4) fill.	WPS must specify: E6010 open root E7018 fill.		Shall weld test coupon using E6010 F3 open root (no back) and E7018 F4 fill passes (with weld metal backing).	Range qualified: F-No. 3 with and without backing. F-No. 4 with backing and fillet welds, partial pene. both sides & buildup.
WPQ # 342 (Table 5.3).			Same as Example 10.22.3.	

QW-301.2 notes that the welder who welds the WPS qualification test coupon (PQR), meeting the requirements of QW-200, is also qualified within the limits of QW-304, but only within the limits for positions specified in QW-303. Actually, when the PQR test coupon is successfully tested, so also is the welder, but not until the paper work of QW-301.4 has been completed (see chapters 2 and 5). The

# Chapter 11

## **TESTING AND EXAMINATION REQUIREMENTS FOR PERFORMANCE QUALIFICATION**

This chapter provides the Code user with the testing and examination requirements for the qualification of welders and welding operators. Test coupons must be welded, tested, and the results recorded on a Welders Performance Qualification Record (WPQ). These WPQ tests are prepared to demonstrate the welders ability to deposit sound weld metal.

Chapters 1 through 7 guided the Code user through the steps necessary to prepare the WPS and document the qualification tests on a PQR. This Chapter outlines 18 Code requirements, presented in a step by step manner, to guide the Code user in the preparation of the WPQ test coupons, preparing test specimens and examination and testing for the performance qualification of welders. There are alternate methods of qualifying welders and welding operators, and those alternate methods are discussed in this chapter. The testing requirements for the qualification of a WPS are covered in Chapter 8.

### **Outline of Testing Requirements for Qualification of a Welders Performance (WPQ)**

- |         |  |
|---------|--|
| Step 1  | Code user's responsibility.                        |
| Step 2  | Options for welder's tests.                        |
| Step 3  | Visual and mechanical tests.                       |
| Step 4  | Test coupon requirements.                          |
| Step 5  | Type and number of mechanical test specimens.      |
| Step 6  | Visual examination.                                |
| Step 7  | Specimen removal.                                  |
| Step 8  | Bend specimens.                                    |
| Step 9  | Mechanical tests.                                  |
| Step 10 | Types of bend test jigs.                           |
| Step 11 | Test jig dimensions.                               |
| Step 12 | Specimen thickness and bend radius.                |
| Step 13 | Acceptance criteria - bend tests.                  |
| Step 14 | <b>Alternate</b> to mechanical tests.              |
| Step 15 | <b>Alternate</b> processes and materials.          |
| Step 16 | <b>Alternate</b> radiographic acceptance criteria. |
| Step 17 | PQR test coupon - welder also qualifies WPQ.       |
| Step 18 | Welder performance qualification (WPQ) record.     |

### Step 1 Code Users Responsibilities

QW-300.2 The Code user shall be responsible for conducting tests to qualify welder performance in accordance with qualified WPSs which the Code user employs in the construction of weldments built in accordance with the Code.

The welders used to produce such welds are tested under the full supervision and control of the Code user. It is not permissible to have this welding done by another organization. It is acceptable to subcontract the work of test materials preparation and subsequent test specimens preparation, provided the Code user accepts responsibility for any such work. In the end, it is the Code user who must supervise the welding of the WPQ test coupons. Code users may not subcontract the supervision of the welding for WPQ test coupons.

### Step 2 Options for Welder's Tests

QW-300.1 Welders may be qualified by:

- Bend test specimens removed from a test coupon,
- Radiography of a test coupon,
- Radiography of the welders initial production welding.

### Step 3 Visual and Mechanical Tests

QW-304 Each welder who welds under the rules of the Code shall have passed the visual examination in QW-302.4 (visual examination of the completed test coupon) and the mechanical tests in QW-302.1. Alternatively, welders may qualify by radiography. (See alternate steps 14, 15, & 16.)

QW-304 allows the WPQ testing to be conducted by either:

- the WPQ test coupon shall be examined visually, and if it passes, the WPQ test coupon shall then be mechanically tested, or
- the WPQ test coupon shall be examined by radiography (see QW-304 for limitations).

### Step 4 Test Coupon Requirements

QW-310.1 The test coupons may be plate, pipe, or other product forms. Test coupons may be a combination of welding processes or procedures, see QW-306.

There are no requirements for the amount of weld metal which must be deposited with each process in a combination test coupon. [Interpretation IX-92-28 covers the amount of weld metal in combination test coupon.]

When all position qualifications for pipe are accomplished by welding one pipe assembly in both the 2G and 5G positions, NPS 6 or larger pipe shall be used, shown in Figure 11.4. See QW-463.2(f) for NPS 10 or larger pipe, or QW-463.2(g) for NPS 6 or 8 pipe.

QW-310.2 and QW-310.3 requires the joint design of the test coupons to be the same as those for any WPS qualified by the Code user. Alternatively, the test coupons shall be as shown in QW-469.1 for welding with backing or QW-469.2 for welding without backing.

WPQ # 342 (Table 5.3) recorded that WPS # 134 was used. This provides verifiable, documented evidence that the weld groove used was the same as one of the WPSs qualified by Company Inc.

Single welded groove weld with backing, double-welded groove welds, partial penetration groove welds, fillet welds, and weld metal buildup are all considered welding with backing.

### Step 5 Type and Number of Mechanical Test Specimens

QW-302.1 The type and number of specimens required for mechanical tests must be in accordance with QW-452.

**Caution:** A test coupon,  $T_c$ , is normally two pieces of metal welded together. This weldment (test coupon  $T_c$ ) is cut into test specimens,  $T_s$ . These test specimens,  $T_s$ , are individually examined or tested as in bend, tension, or impact tests. Please note the subtle difference between  $T_s$  and  $T_c$  for the following:

**Note:** The type and number of bend specimens  $T_s$  are dependent upon the position in which the WPQ test coupon  $T_c$  was welded. For WPQ plate tests welded in the 1G, 2G, 3G, and 4G test positions, two bend tests are required per QW-452.1. For WPQ pipe tests welded in the 5G or 6G test positions, four bend tests are required per note (4) of QW-452.1. Six bend tests are required for WPQ pipe tests welded in the 2G plus 5G test positions on a single test coupon (see Figure 11.4).

QW-452.1 (Table 11.1) covers transverse bend tests (Figure 11.5). Figure 11.3 shows QW-463.2 (a) and a photograph of transverse bend specimens which are cut at right angles to the progression of the weld. QW-452.1 requires face and root bends when the test specimens  $T_s$  are less than  $\frac{3}{8}$  inch (10 mm). QW-452.1 requires side bends when the test coupon,  $T_c$ , is  $\frac{1}{2}$  inch (13 mm) and thicker. The type of bend is optional when the test coupon,  $T_c$ , or the test specimen,  $T_s$ , is  $\frac{3}{8}$  inch (10 mm) up to but not including  $\frac{1}{2}$  inch (13 mm) thick. The thickness of the test specimen,  $T_s$ , should be used in the *Thickness of Test Coupon  $T_s$  welded, inch* column of Table QW-452.1 in place of the test coupon,  $T_c$ , when the final thickness of the test specimen,  $T_s$ , is less than  $\frac{3}{8}$  inch (10 mm). For example, QW-452.1 would seem to allow an option if an as-welded test coupon,  $T_c$ , is  $\frac{7}{16}$  inch (11 mm) thick, but in the end, if the prepared test specimen,  $T_s$ , is less than  $\frac{3}{8}$  inch (10 mm) thick, the test specimen must be face and root bend tested. See step 8 of this chapter.

Table 11.1 QW-452 Performance Qualification Bend Tests.

<b>QW-452.1 Transverse-Bend Tests</b>				
<b>Type of Joint</b>	<b>Thickness of Test Coupon T<sub>c</sub> Welded, inch (mm)</b>	<b>Type &amp; Number of Tests Required (Guided-Bend Tests) [Notes (3), (4), (5)]</b>		
		<b>Side-Bend QW-462.2 Face Bend QW-462.3(a) Root Bend QW-462.3(a) [Note (6)]</b>		
Groove	Up to 3/8 (10), incl.	Note (7)	1	1
Groove	> 3/8 (10)	Note (8)	1	1
Groove	1/2 (13) and over	2	...	...
<b>Notes:</b>				
(3) Thickness of test coupon of 1/2 inch (13 mm) or over shall be used for qualifying a combination of three or more welders each of which may use the same or a different welding process.				
(4) To qualify for positions 5G & 6G per QW-302.3, two root and two face bends or four side bend specimens, as applicable to the test coupon thickness, are required. <b>Note:</b> To qualify for both positions 2G and 5G on a single pipe test coupon, six bend specimens are required.				
(5) Test coupons shall be visually examined per QW-302.4.				
(6) Face- and root-bend tests may be used to qualify a combination test of: (a) one welder using two welding processes; or (b) two welders using the same or a different welding process.				
(7) For a 3/8 inch (10 mm) thick coupon, two side bends may be substituted for each of the required face and root bend tests.				
(8) A side-bend test may be substituted for each of the required face- and root-bend tests.				
(9) Test coupon weld deposit shall also consist of a minimum of three layers of weld metal.				

**Step 6 Visual Examination**

QW-302.4 states that prior to mechanically cutting the bend specimens, visual examination per QW-190 is required:

1. for plates (except for the discard),
2. for pipe over the full circumference inside and outside.

**Note:** Visual examination is required prior to mechanical testing but not prior to radiographic examination.

Performance test coupons must be visually examined and show complete joint penetration with complete fusion of weld and base metal as stipulated in QW-190. See Figure 11.1 for examples of incomplete fusion and incomplete joint penetration.

# Chapter 12

## **EXPIRATION, REVOCATION, RETESTS, RENEWAL AND REQUALIFICATION OF PERFORMANCE QUALIFICATION**

New welders may fail one or more of their initial welder's performance qualification (WPQ) tests. Welders qualifications expire if they do not use the process at least once every six months, or may have their WPQ revoked if there is a specific reason to question their ability to make welds that meet required specifications. Welders may also fail one or more of their renewal tests. This chapter discusses how welders qualifications may expire or be revoked, and some of the rules for re-testing and renewal of a welder's qualifications and the associated documentation. See Chapter 11, step 3 for alternatives for the testing and examining WPQ of test coupons.

Chapter 11, steps 6 and 11, define the QW-302.4 requirement for the visual examination prior to the required mechanical testing.

### **QW-322 Expiration, Revocation, Renewal and Requalification of Qualifications**

#### **QW-322.1(a) Expiration of Qualification.**

When he has not welded with a process during a period of 6 months or more, the welder's qualifications for that process shall expire; unless, within the six month period, prior to his expiration of qualification,

- (1) a welder has welded using a manual or semiautomatic welding process which will maintain his qualification for manual and semiautomatic welding with that process.

**Note:** QW-322.1(a) is subdivided into QW-322.1(a)(1) for welders and (a)(2) for welding operators. This split is intended to point out that Code Users must maintain the continuity of welders and welding operators separately.

- (2) a welding operator has welded with a machine or automatic welding process which will maintain his qualification for machine and automatic welding with that process.

**Note:** QW-322.2(a) Renewal of Qualification, is stated only once, with the expression, in the second sentence, "renews the welders or welding operator's..." This reference is intended to highlight that the Code User must maintain the continuity of their welders and welding operators separately.

**QW-322.2(a) Renewal of Qualification.**

Renewal of qualification expired under QW-322.1(a) above may be made for any process by welding a single test coupon of either plate or pipe, of any material, thickness, or diameter, in any position and by testing of that coupon as required by QW-301 and QW-302. A successful test renews the welder or welding operator's previous qualifications for that process and for those materials, thicknesses, diameters, positions, and other variables for which he was previously qualified.

Providing the conditions of QW-304 and QW-305 are satisfied, renewal of qualification under QW-322.1(a) may be done on production work.

There are many reasons why a welder may not have welded with a process. The welder may have been off work due to an injury, or may have been laid off due to production demands. The welder may have been promoted to a supervisory position or may be qualified for several process, but has a special process which is used only once in two or three years. Whatever the reason, when a welder has not used a process for six months or more, all qualifications with that process can be renewed by successfully qualifying on a single WPQ renewal test coupon as shown in Example 12.1.1.

**QW-322.1(b) Expiration (Revocation) of Qualification.**

When there is a specific reason to question his ability to make welds that meet the specification, the qualifications which support the welding he is doing shall be revoked. All other qualifications not questioned remain in effect.

There are several reasons to question a welder's ability. A Code user should have a quality program with an enabling procedure to define who within the organization has the authority to question a welder's ability and which outside Inspection Authorities have this same authority. A specific reason is not a frivolous reason, such as "spatter is a sign of poor welding, therefore the welder's ability is questioned." A specific reason may be, for example, that out of 10 welders, one has consistently unacceptable radiographic quality or consistent leakage at the time of the final pressure test. In any case, when the authorized person questions a welder's ability for a specific reason, the qualifications, which support the welding in question, are revoked, lost, gone! The welder must re-qualify for any of those lost qualifications, from the beginning, as defined in chapter 10 and QW-301 and QW-302, in order for the welder to continue to make Code welds.

**Note:** None of the welds previously made by the welder are required to be re-inspected.

**QW-322.2(b) Renewal (Requalification) of Qualification.**

Welders and welding operators whose qualifications have been revoked under QW-322.1(b) above shall requalify. Qualification shall utilize a test coupon appropriate to the planned production work. The coupon shall be welded and tested as required by QW-301 and QW-302. Successful test restores the qualification.

Revoked means no qualification remains. The Code user shall fully qualify each welder revoked, for those qualifications the Code user requires for that welder. The Code user must treat these needed qualifications as new qualifications. No renewals.

**Example 12.1.1** The welder made a ¼ inch (6.4mm) thick, 1G plate test coupon, with backing, using an F-Number 4 filler with the SMAW process. This single WPQ renewal test coupon renewed this welder for all the valid SMAW WPQ's for which he was previously qualified.

**Example 12.1.1**, illustrates that several variables are renewed when a welder renews his qualification ranges for several WPQs by welding this single P-Number 1 WPQ renewal test coupon,  $T_c$ , as follows:

- The 1G test position, renewed qualifications for all positions with the F-Number 4 filler.
- The 1G test position, renewed the flat and horizontal positions with the F-Number 5 filler.
- Using an F-Number 4 filler metal, renewed qualifications for the F-Number 5 filler.
- Welding with backing, renewed the qualifications for F-Number 4 filler without backing.

Welding a ¼ inch (6.4mm) thick weld, renewed the qualifications for F-Number 5 filler metal for ¾ inch (19.1mm) maximum weld metal thickness and the F-Number 4 filler metal for unlimited weld metal thickness.

**Note:** The renewal WPQ test coupon of Example 12.1.1 does not renew the GTAW WPQ 6.

Table 12.1 QW-322.2(a) Renewal of Qualification

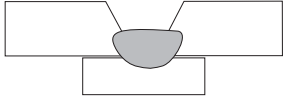
Welding Application	WPS	PQR	WPQ	
WPQs expired or revoked.	Specify:	Record:	 <p data-bbox="1122 915 1378 963">WPQ renewal test coupon 1G plate with backing</p> <p data-bbox="1182 984 1318 1012">Figure 12.1</p>	
Valid WPQs previously qualified.	Variable ranges	Actual values	Renewal WPQ.	WPQ's renewed.
<p data-bbox="190 1125 415 1155"><b>Example 12.1.1:</b></p> <p data-bbox="190 1157 415 1186">Previous WPQs:</p> <p data-bbox="190 1188 415 1218">WPQ 5, SMAW</p> <p data-bbox="190 1220 415 1249">F-No. 5, 2G plate,</p> <p data-bbox="190 1251 415 1281"><math>T_c = t_c = \frac{3}{8}</math> in.,</p> <p data-bbox="190 1283 415 1312">with backing.</p> <p data-bbox="190 1314 415 1344">-----</p> <p data-bbox="190 1346 415 1375">WPQ 4, SMAW</p> <p data-bbox="190 1377 415 1407">F-No. 4, 6G NPS 2 pipe,</p> <p data-bbox="190 1409 415 1438">no backing,</p> <p data-bbox="190 1440 415 1470"><math>T_c = t_c = \frac{3}{4}</math> in.</p> <p data-bbox="190 1472 415 1501">-----</p> <p data-bbox="190 1503 415 1533">WPQ 6, GTAW.</p> <p data-bbox="190 1535 415 1564">F-No. 6, 6G, no backing.</p>	Essential variables	Essential var. Tests and results Other data	WPQ renewal $T_c$ P-No. 1, flat plate, F-No. 4, $t_c = \frac{1}{4}$ in. 1G, with backing.	Requalifies WPQ 5 and WPQ 4 but does not requalify WPQ 6.
<p data-bbox="190 1587 415 1617"><b>Example 12.1.2:</b></p> <p data-bbox="190 1619 415 1648">Welder has the same qualifications as in Example 12.1.1, but has ability questioned welding an NPS 2 pipe with F-No. 4.</p>	Nonessential var. Other directions			Welder retains: WPQ 5 and WPQ 6 but loses WPQ 4. The welder must requalify for any F-No. 4 by full qualification.



Table 12.3 Sample Welders Log to Comply With QW-322.1(a)

<b>Company Inc. Welder Continuity Record 1995</b>														
<b>Welder's Name</b>	<b>ID</b>	<b>Weld Process</b>	<b>First Quarter</b>			<b>Second Quarter</b>			<b>Third Quarter</b>			<b>Fourth Quarter</b>		
			<b>Jan.</b>	<b>Feb.</b>	<b>Mar.</b>	<b>Apr.</b>	<b>May</b>	<b>June</b>	<b>July</b>	<b>Aug.</b>	<b>Sept.</b>	<b>Oct.</b>	<b>Nov.</b>	<b>Dec.</b>
Peat Bog	pb	SMAW	01 318					30 341				03 387		
		GTAW	01 318						July 2, GTAW WPQ expired			03 retest	03 391	11 411
Pierrine Nau	pn	SMAW		20 321				07 332			14 361			24 393
		GMAW		20 323				09 332			15 361			25 394
		GTAW		20 326				08 332			16 361			26 395
Peter Loch	pl	SMAW		20 326				09 332			15 361			24 393
		GTAW										03 387*		24 457
Peet Moss	pm	SMAW		20 321				30 342				21 372	03 387	
		GTAW			17 test							15 test		
Pecka Koski	pk	SMAW	02 pract							01 pract				9 pract
		GTAW	02 pract							01 pract				9 pract
Petrof Reptski	★	SMAW		20 321				17 340				21 372	03 387	
		GTAW m	01 318					18 340			15 361			24 393
		GTAW a	01 318					21 341			15 361			24 457
		SMAW												
		GTAW												

For example, the first entry under Jan. is 01 318, where 01 indicates the date of January 1, 1995 and 318 is the work order #.

\* Peter Loch had his first GTAW production weld radiographed, allowed by QW-304, to renew his GTAW WPQ.

The supervisor shall insert the work order # (WO #), initials and date for each process when used by each welder. This record should be completed for each welder and each process at least quarterly.

Welders shall not be permitted to weld more than six months beyond the last entry on this form for each process.

# Chapter 13

## WELDING VARIABLES FOR WELDING OPERATORS

This Chapter provides the Code user with definitions for some of the unique requirements for welding operators, including the separation of machine or mechanized versus automatic welding processes. The term “welder” and “welding operator” are referred to throughout Section IX. There are important qualification differences between welders and welding operators.

To determine what welding operators are within the rules of Section IX, a Code user must rely on QW-492 Definitions and AWS A3.0 Standard Welding Terms and Definitions. Code users frequently transpose the requirements of welders and welding operators because they do not read one as being different from the other. This chapter examines the definitions of welder and welding operator and the difference between them. Section IX definitions:

- *welder*: One who performs manual or semiautomatic welding.
- *welding, manual*: Welding wherein the entire welding operation is performed and controlled by hand.
- *welding, semiautomatic arc*: Welding with equipment which controls only the filler metal feed. The advance of the welding is manually controlled.
- *welding operator*: One who operates machine or automatic welding equipment.
- *welding, machine*: Welding with equipment which performs the welding operation under the constant observation and control of a welding operator. The equipment may or may not perform the loading and unloading of the work. See automatic welding.
- *welding, automatic*: Welding with equipment which performs the welding operation without adjustment of the controls by a welding operator. The equipment may or may not perform the loading and unloading of the work. See automatic welding. See machine welding.

**Welders** perform manual and semiautomatic welding with special rules under QW-304. Manual processes include the SMAW and GTAW processes. Semiautomatic arc welding processes include the GMAW, FCAW, and SAW processes.

**Welders** have manipulative control of the electrode holder for manual welding and manipulative control of the “welding torch” (AWS) for semiautomatic welding.”

**Welding operators** perform machine or mechanized welding with special rules under QW-305 and as further detailed in QW-361.2. The AWS considers *machine* a nonstandard term for mechanized and defines *mechanized welding* as “welding with equipment that requires manual adjustment of the equipment

# Chapter 14

## ***SUPPLEMENTARY ESSENTIAL VARIABLES***

This chapter explains the use of supplementary essential variables (SEV) when qualifying a welding procedure specification (WPS) in accordance with ASME Section IX. This chapter has been prepared for the Code user who has a complete understanding of the basic requirements of the Code. Each step leading up to the use of supplementary essential variables is discussed. Each supplementary essential variable as it applies to the shielded metal-arc welding (SMAW) process is reviewed.

**Note:** Section IX uses the term *notch-toughness test* (QW-200.3), whereas ASME Section VIII, Div. 1 uses the terms *Charpy impact test*, *Charpy V-notch test*, and *impact test* (UG-84). For most practical purposes, these terms are interchangeable within these codes.

### **Notch-Toughness Tests**

Section IX does not establish when notch-toughness tests are required. Notch-toughness requirements are established in the construction code by specifying impact test requirements for the welding procedure qualification. See QW-170.

QW-171.1 Charpy V-notch impact tests shall be made when required by other sections (i.e. construction codes).

QW-171.2 states acceptance criteria shall be made per that section (construction code) specifying the impact test requirements.

QW-171.3 states the impact test specimen and notch location and orientation shall be as given in the section (construction code) requiring such impact tests.

QW-171 notes that all requirements for notch-toughness are specified by the construction code.

**Exception:** Subcommittee IX added QW-463.1(f), (Figure 14.1), which specifies the notch-toughness test specimen location. The subcommittee concluded that the heat input varied for PQR test coupons welded in the 5G and 6G positions. QW-171.3 was coincidentally revised to add a second sentence which states, “When qualifying pipe in the 5G and 6G position, the notch-toughness specimens shall be removed from the shaded portion of QW-463.1(f).” These shaded portions of the pipe welded test coupons are considered the areas where the highest heat input normally occurs.

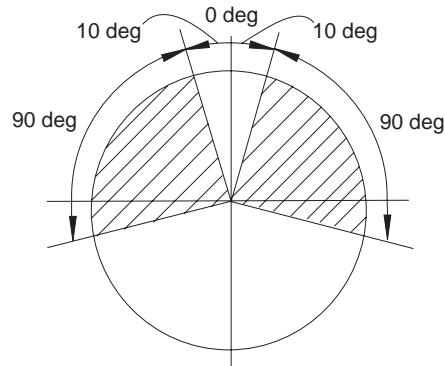


Figure 14.1 QW-463.1(f) toughness specimen removal.

QW-200.1 states in part that a complete WPS shall describe in detail all the essential, nonessential, and when required, supplementary essential variables for each welding process used in the WPS. These variables are listed in QW-250 through QW-280, and are defined in Article IV, Welding Data.

QW-200.2 states in part that a PQR is a record of the welding data used to weld a test coupon. The completed PQR shall document all essential and, when required, supplementary essential variables of QW-250 through QW-280 for each welding process used during the welding of the test coupon.

QW-200.3 describes the addition of Group Numbers to P-Numbers. Group Numbers sub-classify the base metals within P-Numbers for the purpose of procedure qualification when notch-toughness requirements are specified by the construction code. When notch-toughness is a consideration, it is presupposed that the base metals meet the specific requirements of the construction code. In general, notch-toughness requirements are mandatory for all P-Number 11 quenched and tempered metals, for low temperature applications of other metals as applied to ASME Section VIII, Div. 1, and for various classes of construction required by ASME Section II Parts A and B.

QW-250 lists all the essential, supplementary essential, and nonessential variables by process, that must be described on a WPS (QW-200.2).

QW-253 (Table 3.3) is an example of both the essential and nonessential variables for the (SMAW) process. QW-253 (Table 3.3) also lists the supplementary essential variables. These are simply additional essential variables, which must be applied and recorded on the PQR and specified on the WPS, when impact testing has been specified by the construction code.

QW-401.1 describes essential variables as a change in a welding condition, which will affect the mechanical properties (other than notch-toughness) of the weldment.

QW-401.3 describes supplementary essential variables as a change in a welding condition, which will affect the notch-toughness properties of a weldment.

## History of Supplementary Essential Variables - 1974 Edition

Prior to the 1974 Edition of Section IX, there were only essential variables and nonessential variables. The rules for notch-toughness applications were simply essential variables for all applications. The Subcommittee IX decided that there were very few notch-toughness applications, and therefore, the notch-toughness rules should be separated from the non-notch-toughness procedure qualification rules. The 1974 Edition of Section IX was the first edition with the rules for notch-toughness separated from the essential variables as supplementary essential variables. In this manner, the more restrictive rules for notch-toughness need only be applied when notch-toughness is a requirement of the construction code.

ASME Section VIII, Div. 1, UCS-66, UCS-67, and UCS-68 require that a minimum design metal temperature (MDMT) be established for all vessels built to the requirements of the Code and an evaluation of the operating conditions of these vessels to determine if impact testing will be required. Section VIII, Div. 1, UG-20 requires the MDMT to be established for the lowest operating temperature, operational upsets, auto-refrigeration, atmospheric temperature, or any other sources of cooling. These “UCS” rules were introduced into ASME Section VIII, Div. 1, in 1987, and have caused a large increase in the requirement for impact testing and the application of supplementary essential variables for the qualification of the WPS. Section VIII, Div. 1, Part UHT also requires impact testing for the ferritic materials with properties enhanced by heat treatment, and there are additional rules in ASME Section III, ASME B31.3 and other construction codes.

## Notch-Toughness

A material’s notch-toughness property, may be reduced with an increase in heat input. The increase in heat input may be in the form of a higher welding heat input, a higher maximum interpass temperature, a longer post weld heat treatment (PWHT) time at temperature, a reduction in base metal thickness, a change to an uphill progression in vertical welding, a change from stringer bead to weave bead welding, and the location of the test specimen in some pipe test coupons as shown in Figure 14.1. Supplementary essential variables were developed so they could be documented on the PQR, and controls established on the WPS to assure that the heat input would not exceed that value established on the PQR. A Code user is therefore expected to establish a WPS, which will control heat input to assure the notch-toughness properties of the weld metal, base metal, and weldment heat affected zone will not be deteriorated.

This guide will use the terms *notch-toughness* and *non-notch-toughness*. The term *non-notch-toughness* covers those applications where the Code requires only the ultimate tensile strength and ductility properties of a PQR test coupon to be established. The term *notch-toughness* covers those applications where the notch-toughness properties of a PQR test coupon are to be established, in addition to the non-notch-toughness properties.

## Construction Code

When the construction code establishes impact testing for the qualification of the WPS, the Code user will find the variables for the WPS in QW-250 for each process. QW-253 may be used as an example for the SMAW process (Table 3.3). These variables are described in QW-400 in the weld data bank. The following is a brief explanation of some of the supplementary essential variables required for the SMAW process. For the purposes of preparing a WPS and a PQR, supplementary essential variables are to be considered as additional essential variables (Section IX, Introduction).

# Chapter 15

## **REVIEW OF ARTICLE V – STANDARD WELDING PROCEDURES SPECIFICATIONS**

### **Standard Welding Procedure Specification History**

Standard Welding Procedures have been available for many years. Initially they were called “Pre-qualified Welding Procedure Specifications (WPS).” The Certified Pipe Welding Bureau, the American Welding Society (AWS) Structural Code and other codes and standards have used them. These Pre-qualified WPS were developed by consensus committee action based upon the experience of each of the above groups. Some codes and standards would not accept the concept of pre-qualified WPS, as they wanted each Code user to qualify their own WPS.

The AWS was asked to develop Standard Welding procedure Specifications, SWPS. AWS entered into an agreement with the Welding Research Council (WRC) and formed a WRC Welding Procedure Committee (WRC/WPC). Representatives of most industry groups that used welding were invited to participate in the development of SWPSs. The WRC/WPC wanted to prepare SWPSs based upon extensive testing. The WRC/WPC intended to conduct extensive testing of each SWPS in nationally recognized laboratories, under the observation of nationally recognized inspection agencies. The cost of the initial WPS testing was beyond the means of AWS and WRC. A decision was made to solicit industry for copies of their Procedure Qualification Records (PQR), which would support the SWPSs prepared by the WRC/WPC.

Industry responded and today the AWS has thousands of these PQRs solicited from industry, which support the SWPSs. Industries and societies quickly adopted the SWPSs, but others were reluctant to do so. In the 1998 edition, the National Board of Boiler and Pressure Vessel Inspectors (National Board) adopted a few of the SWPSs into their National Board Inspection Code (NBIC). The NBIC is used for repairs to pressure retaining items (boilers, pressure vessels, piping, etc.).

In 1991 the ASME Boiler and Pressure Vessel Code Main Committee formed a Task Group to review the SWPSs published by AWS, for applicability to boiler and pressure vessel new construction. The Task Group was to determine if the procedures had adequate technical support for use in ASME boiler and pressure vessel construction. ASME had always required the manufacturer to qualify its own procedures, and now, ASME was going to allow the manufacturer to use welding procedure specifications essentially qualified by someone else. ASME wanted to insure that these SWPSs produce the mechanical properties needed for ASME Code work. Another objective of the Task Group was to determine if there were any administrative procedures that would have to be changed in order for the Boiler Codes to adopt SWPSs.

The Task Group was directed to review and recommend for adoption a limited number of basic SWPSs for boiler and pressure vessel construction. The Task Group recommended several SWPSs appropriate for use in the boiler and pressure vessel industry.

ASME Subcommittee IX (SCIX) was directed to determine how SWPSs could be adopted into Section IX for ASME Code Construction. SCIX determined that while the SWPSs were supported with technical data, there might not be any assurance that the Code user would know how to use these SWPSs.

Subcommittee IX added Article V to Section IX, which specifies the requirements with which the Code user must comply before using SWPSs in ASME Code construction. The major addition to Section IX is the requirement to demonstrate the Code users' ability to use the specific SWPS. Besides the demonstration, other requirements include documentation and restrictions in production use of SWPSs.

The 2000 Addenda to ASME Section IX permits the use of SWPSs, provided the Code user complies with the additional requirements of Section IX, and the referencing ASME construction Code, and all other requirements of the ASME Boiler and Pressure Vessel Codes. ASME authorized seventeen SWPSs in the ASME Section IX, 2000 addenda.

This chapter will discuss what a Code user must do before using an SWPS to produce a Code constructed item. This chapter will also discuss welder qualifications as they relate to SWPSs, and finally, we'll compare the use between SWPSs and ASME Section IX procedures, and welder qualifications for both cases.

## **Using Standard Welding Procedure**

### **Specifications - SWPSs**

Provisions for SWPSs were added to ASME Section IX in the 2000 addenda. These provisions were added as Article V, which maybe difficult to locate. Article V is found following the massive Article IV –'Welding Data', and immediately before Article XI, 'Brazing'.

Article V allows only a selected few SWPSs, approved for use by Section IX. QW-500 specifies that only SWPSs listed in Mandatory Appendix E can be used in ASME Boiler and Pressure Vessel Construction. See Figure 15.1. Article V also stipulates that requirements of the Construction Code regarding SWPSs take precedence over the requirements of Section IX. This means that even though Section IX permits the use of SWPSs, the construction code must specifically allow the use of SWPSs for the type of construction being considered.

This guide selected a commonly used SWPS from Appendix E of Section IX as a reference for this chapter. This guide selected SWPS ANSI/AWS B2.1-1-026-94 which has been reproduced in Appendix 5 of this guide, as a courtesy of the American Welding Society, 550 N W LeJeune Road, Miami Florida 33126.

### **QW-500 General**

The SWPSs listed in Appendix E of Section IX are acceptable for construction in which the requirements of Section IX are specified. This is all Section IX can address. Any requirements of the applicable reference Code take precedence over the requirements of Section IX. There are other applications, which also specify SWPSs, as noted in the introductory history section of this chapter.

Figure 15.1 Mandatory Appendix E – Permitted SWPSs

### Appendix E—Mandatory Permitted SWPSs

The following Standard Welding Procedure Specifications may be used under the conditions given in Article V.

Specification	Designation
<b>Carbon Steel</b>	
<b>Shielded Metal Arc Welding</b>	
Standard Welding Procedure Specification for Shielded Metal Arc Welding of Carbon Steel (M-1/P-1/S-1, Group 1 or 2), 1/8 through 1 1/2 inch Thick, E7018, As-Welded or PWHT Condition	B2.1-1-016-94
Standard Welding Procedure Specification for Shielded Metal Arc Welding of Carbon Steel (M-1/P-1/S-1, Group 1 or 2), 1/8 through 1 1/2 inch Thick, E6010, As-Welded or PWHT Condition	B2.1-1-017-94
Standard Welding Procedure Specification for Shielded Metal Arc Welding of Carbon Steel (M-1/P-1/S-1, Group 1 or 2), 1/8 through 1 1/2 inch Thick, E6010 (Vertical Uphill) Followed by E7018, As-Welded or PWHT Condition	B2.1-1-022-94
Standard Welding Procedure Specification for Shielded Metal Arc Welding of Carbon Steel (M-1/P-1/S-1, Group 1 or 2), 1/8 through 1 1/2 inch Thick, E6010 (Vertical Downhill) Followed by E7018, As-Welded or PWHT Condition	B2.1-1-026-94
<b>Combination GTAW and SMAW</b>	
Standard Welding Procedure Specification for Gas Tungsten Arc Welding Followed by Shielded Metal Arc Welding of Carbon Steel (M-1/P-1/S-1, Group 1 or 2), 1/8 through 1 1/2 inch Thick, ER70S-2 and E7018, As-Welded or PWHT Condition	B2.1-1-021-94
<b>Carbon Steel – Primarily Pipe Applications</b>	
<b>Shielded Metal Arc Welding</b>	
Standard Welding Procedure Specification (WPS) for Shielded Metal Arc Welding of Carbon Steel (M-1/P-1/S-1, Group 1 or 2), 1/8 through 3/4 inch Thick, E6010 (Vertical Uphill) Followed by E7018 (Vertical Uphill), As-Welded Condition, Primarily Pipe Applications	B2.1-1-201-96
Standard Welding Procedure Specification (WPS) for Shielded Metal Arc Welding of Carbon Steel (M-1/P-1/S-1, Group 1 or 2), 1/8 through 3/4 inch Thick, E6010 (Vertical Downhill) Followed by E7018 (Vertical Uphill), As-Welded Condition, Primarily Pipe Applications	B2.1-1-202-96
Standard Welding Procedure Specification (WPS) for Shielded Metal Arc Welding of Carbon Steel (M-1/P-1/S-1, Group 1 or 2), 1/8 through 3/4 inch Thick, E6010 (Vertical Uphill), As-Welded Condition, Primarily Pipe Applications	B2.1-1-203-96
Standard Welding Procedure Specification (WPS) for Shielded Metal Arc Welding of Carbon Steel (M-1/P-1/S-1, Group 1 or 2), 1/8 through 3/4 inch Thick, E6010 (Vertical Downhill Root with the Balance Vertical Uphill), As-Welded Condition, Primarily Pipe Applications	B2.1-1-204-96
Standard Welding Procedure Specification (WPS) for Shielded Metal Arc Welding of Carbon Steel (M-1/P-1/S-1, Group 1 or 2), 1/8 through 1 1/2 inch Thick, E6010 (Vertical Uphill) Followed by E7018 (Vertical Uphill), As-Welded or PWHT Condition, Primarily Pipe Applications	B2.1-1-205-96



## Welders Performance Qualification for SWPSs

There are no specific rules in Section IX that discuss welder performance qualification for using SWPSs. However, welders must be qualified in accordance with Section IX for performance qualifications before the welders may weld using an SWPS. The rules are the same as though the welders were welding using a WPS qualified in accordance with Section IX rules.

Chapter 10 of this guide describes the rules for the preparation and review of a welder's performance qualification (WPQ record). The following examples compare the WPQ record of Peat Bog (Chapter 5, Table 5.3), with the welder performance qualification variables of Article III, to see if Peat Bog is qualified to use AWS SWPS B2.1-1-026-94.

**QW-403.18 Base Metal P-Numbers.** SWPS B2.1-1-026-94 is qualified for welding P-Number 1 materials. Therefore, the welder must have qualifications on a base metal that qualifies the welder to weld on P-Number 1. Peat Bog's test coupon was SA-106, Grade B, which according to Section IX paragraph QW-423.1 qualifies Peat to weld base metal of P-No. 1 through P-No. 11, P-No. 34, and P-No. 41 through P-No. 47. For the variable of base metal, Peat Bog is qualified to use SWPS B2.1-1-026-94.

**QW-404.15 Filler Metal, F-Numbers.** SWPS B2.1-1-026-94 requires the use of F-No. 3 and 4 filler metals. Reviewing Peat Bog's qualification record in Table 5.3, we discover that Peat Bog welded using E6010 and E7018 for his performance qualification test. Therefore, Peat Bog has the necessary qualifications to weld with the filler metals required by SWPS B2.1-1-026-94.

**QW-405.1 Positions.** Peat Bog took his qualification test in the 2G position, according to Table 5.3. Reviewing Table 10.9 we find that test coupons welded in the 2G position qualify welders for welding positions of flat and horizontal. SWPS B2.1-1-026-94 specifies it is qualified for use in all positions. Peat Bog however, will be restricted to using this SWPS while welding in the flat or horizontal positions only.

**QW-405.3 Welding Progression.** This variable is applicable only when vertical progression is a factor, such as test positions 3G, 5G and 6G. Since Peat Bog did not weld using a vertical progression, this variable is not applicable. Remember however, Peat Bog is restricted to welding in the flat and horizontal positions only.

**QW-403.16 Base Metal Pipe Diameters.** SWPS B2.1-1-026-94 specifies it can be used for groove welds in diameters 1 inch (25.4 mm) and larger. Peat Bog ran his test coupon on a NPS 2 pipe which, according to Table 10.14 qualifies him to weld outside diameters of 1 inch (25.4 mm) and larger. For the purpose of pipe diameter, Peat Bog is qualified to weld using SWPS B2.1-1-026-94.

**QW-404.30 Weld Metal Thickness.** AWS SWPS B2.1-1-024-94 allows E6010 to be deposited to a maximum thickness of  $\frac{3}{8}$  inch [9.6 mm (nominal)], and E7018 is used to fill the remainder of the groove, which is  $1\frac{1}{2}$  inch (38 mm) maximum base metal thickness.

Peat Bog used a NPS 2, Schedule 80 pipe for his test coupon. NPS 2, Schedule 80 pipe is nominally  $\frac{7}{32}$  inch (5.6 mm) thick. Section IX allows 2t qualifications for this thickness of weld metal. Table 5.3 indicates Peat Bog deposited  $\frac{3}{32}$  inch (2.4 mm) of E6010 and  $\frac{1}{8}$  inch (3.2 mm) of E7018 for a total weld metal thickness of  $\frac{7}{32}$  inch (5.6 mm). As indicated in Table 5.3, Peat Bog is qualified to deposit a maximum  $\frac{3}{16}$  inch (4.8 mm) of E6010 and  $\frac{1}{4}$  inch (6.4 mm) of E7018 for a total weld metal thickness of  $\frac{7}{16}$  inch (11.1 mm).

# Chapter 16

## MISCELLANEOUS

This chapter covers some of the qualification features unique to the following specialty areas. Each area will be handled as a sub-section as follows:

- Filler Metal Specifications and Classifications
- Low Voltage Short Circuiting - GMAW-S
- Tack Welding
- Part QB Brazing
- Root Process Combinations QW-200.4(b)
- Corrosion Resistant Weld Metal Overlay (CRWMO)

### Filler Metal Specifications, Classifications and Supplemental Designators

#### Specifications

ASME has adopted the AWS A5.X series of specifications for weld filler metals for use within the ASME Codes to reduce the number of tests required for both procedure and performance qualifications. When ASME adopts an AWS A5.X specification, ASME assigns an “S” to indicate the specification has been adopted by ASME, and an “F”, to indicate the specification is for filler metal. ASME has always adopted the AWS A5.X series of specification, without change. As such, the AWS A5.X and the ASME SFA-5.X specifications have been identical to date. The foreword of the ASME codes, therefore, allow for the use of either AWS or ASME specifications and classifications. The common specification used for mild steel covered electrodes for use with the shielded metal arc welding (SMAW) process is ASME SFA-5.1 (AWS A5.1). In this chapter, we will refer to the SFA specifications. SFA-5.1 covers the E6010 and E7018 low hydrogen covered electrodes referred to throughout this guide. More detailed information about AWS filler metal specifications and data can be found in the *CASTI Metals Blue Book™ - Welding Filler Metals*.

The designation system of the SFA series of specifications are summarized as follows.

- The S indicates the specification has been adopted by ASME.
- The F indicates the specification covers filler metals.
- The A indicates the specification was adopted from AWS.
- The 5.XX indicates the sequential numbering of the specifications.

#### Classifications

There are *mandatory classification designators*, which, when combined for a specific electrode, constitute the electrode classification, for example E7018. There are also *optional supplementary designators*, which may be added to the electrode classification, for example the moisture resistant optional “-R” designator.

Within the AWS system, an electrode may only be classified in one specification (SFA-5.1, paragraph 2.2). For example, the E7018 electrode is only classified in specification SFA-5.1, while E7018-A1 is only classified in specification SFA-5.5. The classification system is detailed in SFA-5.1, Appendix A.2, and some of the mandatory classification designators (Table 16.2) for an SFA-5.1, E7018 classification electrode are summarized as follows.

- The E indicates electrode.
- The 70 indicates 70,000 psi [70 ksi (485 Mpa)] minimum tensile strength.
- The 1 indicates the electrode is acceptable for use in all positions.
- The 8 indicates the low hydrogen formulation of the flux and the type of current and polarity for which it is acceptable (Table 6.10).

The combination of these mandatory classification designators constitutes the electrode classification; for example, the E + 70 + (1) + 8 = an E7018 electrode classification.

						Line #
<b>Mandatory Classification Designators: *</b>						1
Designates an electrode. May be deleted from marking on electrode.						2
Designates the tensile strength (minimum) in ksi, of the weld metal when produced in accordance with the test assembly preparation section of this specification. See SFA-5.1, Table 2.						3
Designates welding position in which the electrodes are usable, type of covering, and the kinds of welding current for which the electrodes are suitable. See SFA-5.1, Table 1.						4
Designates an electrode (E7018M) intended to meet most military requirements, (greater notch-toughness, lower moisture content, as received and after exposure). See SFA-5.1, Tables 3, 10 and 11.						5
* <b>Note:</b> The combination of the designators 2 through 5 constitutes the electrode classification.						6
E	XX	YY				7
E	XX	YY	M			
E	XX	YY	-1	HZ	R	<b>Optional Supplemental Designators:</b> Designates that the electrode meets the requirements of the absorbed moisture test (an optional test for low hydrogen electrodes (except E7018M) See SFA-5.1, Table 10. Designates that the electrode meets the requirements of the diffusible hydrogen test (an optional supplemental test for value not exceeding "Z" ml of H <sub>2</sub> per 100 g of weld metal where "Z" is 4, 8, or 16) See SFA-5.1, Table 11. Designates that the electrode (E7016, E7018, or E7024) meets the requirements for improved notch-toughness - and ductility for E7024 - (optional supplemental test requirements shown in SFA-5.1, Tables 2 and 3).
<b>Optional Supplemental Designators:</b>						
Designates that the electrode meets the requirements of the absorbed moisture test (an optional test for low hydrogen electrodes (except E7018M) See SFA-5.1, Table 10.						
Designates that the electrode meets the requirements of the diffusible hydrogen test (an optional supplemental test for value not exceeding "Z" ml of H <sub>2</sub> per 100 g of weld metal where "Z" is 4, 8, or 16) See SFA-5.1, Table 11.						
Designates that the electrode (E7016, E7018, or E7024) meets the requirements for improved notch-toughness - and ductility for E7024 - (optional supplemental test requirements shown in SFA-5.1, Tables 2 and 3).						10

Figure 16.1 Order of electrode mandatory and optional designations.

## Optional and Mandatory Supplemental Designators for SMAW

Mandatory classification designators for carbon steel electrode classifications include SFA-5.1, AWS E6010 and E7018. Mandatory classification designators for low alloy electrode classifications include SFA-5.5, AWS E7018-A1 and E8018-B2. The -A1 and -B2 mandatory classification designators, when combined with the EXX18 mandatory designator constitute the electrode classification. The -A1 and -B2 define the weld metal analysis as shown in SFA-5.5, Table 2.

The optional supplemental designators for carbon steel electrode classifications include SFA-5.1, AWS E7018-1 or E7016-R. The -1 optional supplemental designator, when added to the E7018 mandatory designator indicates that these electrodes meet the requirements for improved notch-toughness properties. The -R optional supplemental designator, when added to the E7016 mandatory designator indicates that these electrodes meet the requirements of the absorbed moisture test. Figure 16.1 (Figure 16 of ASME SFA-5.1 (AWS A5.1)) details the division between the mandatory classification designators and the optional supplemental designators.

Figure 16.1, line #1 indicates the “mandatory classification designators.” Lines #2 through 5 define the identification system used by the AWS as mandatory designators. Line #6 is a note to remind the Code user that those items in lines 2 through 5, when combined, constitute the electrode classification. Line #7 indicates that lines 8, 9 and 10 define the identification system used by the AWS for optional supplemental designators. It is important to understand the difference, since QW-404.12 (Table 14.2) requires requalification of a notch-toughness PQR for a change in an electrode classification, but has numerous exceptions for optional supplemental designators (see Examples 14.2.2 through 14.2.6 and 14.2.11).

Line #5 defines a mandatory classification designator, specifically the “M” designator, which is intended to meet most military requirements. The “M” designator defines the electrode as, more or less, meeting all the other optional supplementary designators. The “M” is a mandatory classification designator, and as such, is an essential part of the classification of an E7018M electrode. Do not treat the “M” as an optional supplemental designator.

An example of an optional supplemental designator is the “-R” designator (Figure 16.1, line #8). SFA-5.1 Appendix A7.6.4 has added a “-R” optional designation which indicates that the electrode manufacturer has tested the product for moisture content of the electrode covering as-received or after conditioning and after exposure to a standard humidity-laden environment. The “-R” signifies that after exposure, the covering has absorbed only a specific small amount of moisture. The electrodes are then exposed to an 80% relative-humidity atmosphere at 80°F (26.7°C) for at least nine hours. If the contents meet standards set in the specification, the electrode qualifies to carry the “-R” optional supplemental designator. The -R quantifies nonstandard terms such as “moisture resistant” that vendors apply to their electrodes.

Table 16.1 Moisture Content Limits in Electrode Coverings

<b>Optional Designator “-R” (indicates moisture content of electrode covering)</b>		
<b>Electrode Designation</b>	<b>Allowable Moisture Content, Weight % Max.</b>	
	<b>As-received or Conditioned</b>	<b>After Exposure to Humid Test Environment</b>
E7015, E7016, E7018, including the -1 designators	0.6%	Not specified
E7015R, E7016R, E7018R including the -1 designators	0.3%	0.4%

## ***INTERPRETATIONS***

**Interpretation:**     **IX-77-01**  
Subject:               Section IX, QW-462.1  
Date Issued:         January 4, 1977  
File:                  BC-76-428

Question: Is it permissible to machine a tension sample below the original surface of the base metal in order to obtain parallel faces over the reduced section?

Reply: No definite limits are set with respect to metal that may be machined off the original thickness. The test plate should be of substantially the same thickness as originally welded, but if a little of the thickness is machined off to obtain parallel rectangular surfaces, the specimen may be accepted. If your procedure wishes to set definite limits you may do so. Section IX is a minimum safety requirement.

**Interpretation:**     **IX-77-04**  
Subject:               Section IX, Tack Welder Qualification  
Date Issued:         January 31, 1977  
File:                  NA

Question: May a welder be qualified as a tack welder if his tack welds were a part of another welder's qualification test coupon or part of another welding procedure qualification test which met the intent of the Code?

Reply: The Code requires that all welders, (including tack welders), must be qualified per Section IX.

**Interpretation:**     **IX-77-19**  
Subject:               Section IX, QW-351  
Date Issued:         September 26, 1977  
File:                  BC-77-469

Question: May a welder qualified in a given procedure, and for a given maximum thickness of deposit, weld on pipe of greater wall thickness, provided the thickness deposited by this welder does not exceed his qualification?

Reply: A welder qualified in a given procedure and for a given maximum thickness may weld on a pipe of greater wall thickness provided the thickness deposited does not exceed his qualification. However, the welder must follow a Welding Procedure Specification (WPS) that has a PQR qualification necessary to weld the full pipe thickness in production.

# SUBJECT INDEX

## A

A-Numbers, 53-56, 128-129

AWS

*see Filler Metals, Specifications and Classifications*

Sample SWPS ANSI/AWS B2.1-1-026-94, 367-379

## B

Backing, 91-95, 205-209

Base Metal, 96-97

*see P-Numbers or Pipe Diameters*

Supplementary Essential Variables, 244-245

Thickness "T" for WPS and PQR, 56-61, 115-118, 125-127

Dissimilar Thickness, 119-122

Bend Tests

Welder Performance Qualification (WPQ)

Acceptance Criteria, 219-221

Bend Specimens, 216-217

Bend Test Jigs, Dimensions, 217-218

Specimen Thickness and Bend Radius, 219

Welding Procedure Qualification (PQR)

Acceptance Criteria, 151-153

Alternative Tests, 139

Methodology, 141

Procedure, 144-146

Specimens, 138-139, 140-141, 142, 143, 147, 148

Brazing, Part QB, 283-285

## C

Charpy V-Notch Test

*see Supplementary Essential Variables, Notch-Toughness Tests, Charpy V-Notch*

Combinations

*see Procedure Qualification Record (PQR), Preparing and Reviewing a PQR, Combination Welding Procedures*

*see Supplementary Essential Variables, Combination of Supplementary Essential Variables*

Root Process Combinations, 285-287

Corrosion-Resistant Weld Metal Overlay (CRWMO), 288-294

Current

Supplementary Essential Variables, 251

**D**

Definitions

*see Section IX, Definitions*

Documentation Forms

*see Welding Documentation Forms*

**E**

Electrical

Welding Procedure Specification (WPS), 105-106

**F**

F-Numbers

*see Filler Metals*

Fillet Weld Procedure Qualification (PQR), 61-62

Filler Metals

AWS Specifications and Classifications

SAW, 276-277

SMAW, 273-275

F-Numbers, 50-52, 130

Supplementary Essential Variables,

Filler Metal Classification, SFA Specification, 245-246

Welder Performance Qualification (WPQ)

F-Numbers, 186-189

Thickness of Weld, 196-202

Combination of Welding Processes QW-306, 196

Combination of Weld Thickness ( $t_d$ ) and Pipe Diameter, 203-205

Welding Variables for Welders, 196-202

Welding Procedure Specification (WPS)

F-Numbers, 97-98

**G**

Gas Metal-Arc Welding (GMAW), 277-280

Group Numbers

*see P-Numbers*

**H**

Heat Input

Supplementary Essential Variable QW-409.1, 251

## I

Interpass Temperature  
 Supplementary Essential Variables, 247-248

International System of Units (SI), 4-5  
 abbreviations in ASME Section IX Code, 5  
 conversion of units, 5, 299-301  
 SI units in ASME Section IX tables, 5

## J

Joints  
 Welding Procedure Specification (WPS)  
   *see Backing*  
   Groove Design, 89-91  
   Root Spacing, Retainers, 91-95

## N

Notch-Toughness  
   *see Supplementary Essential Variables, Notch-Toughness and Notch-Toughness Tests*  
 Nonmandatory Welding Forms, 15

## P

P-Numbers, 42-50, 127-128  
 Group Numbers, 47-48  
   Supplementary Essential Variable, 242-243  
 S-Numbers, 48-50  
 Welder Performance Qualification (WPQ), 182-186  
 Pipe Diameters  
   Welder Performance Qualification (WPQ), 67-69, 203-205  
 Polarity  
   Supplementary Essential Variables, 251  
 Positions  
   Supplementary Essential Variables, 247  
   Welder Performance Qualification (WPQ), 69-73  
   Welding Procedure Specification (WPS), 102  
 Postweld Heat Treatment  
   Procedure Qualification Record (PQR), 131-135  
   Supplementary Essential Variables, 250  
   Welding Procedure Specification (WPS), 104-105  
 Preheat, 103-104, 130-131



Procedure Qualification Record (PQR)

*see also Base Metal, Thickness "T" for WPS and PQR*

*see also Weld, Thickness "t" for WPS and PQR*

*see also Welding Documentation Forms, Sample WPS, PQR and WPQ Forms*

Checklist, 155-180

Documentation Review Certification, 180

Gas Metal-Arc Welding, 161-162

Gas Tungsten-Arc Welding, 159-160

PQR Audit Checklist, 176-178

PQR Supporting the WPS Qualification Audit, 178-180

Shielded Metal-Arc Welding, 157-158

Submerged-Arc Welding, 163-164

WPS Audit Checklist, 173-175

Preparing and Reviewing a PQR, 109-135

A-Numbers, 129

Base Metal Thickness QW-403, 111-114, 115-118

Combination Welding Procedures, 122-125

Dissimilar Thickness QW-202.4, 119-122

F-Numbers, 130

P-Numbers QW-430, 127-128

Preheat QW-406, 130-131

Repair and Buildup QW-202.3, 119-120

Variables, 109-110

Weld Thickness QW-404, 111-114, 125-127

Testing Requirements for Welding Procedure Qualification, 137-153

Bend Tests

Acceptance Criteria, 153

Alternative Tests, 139

Methodology, 142-143

Procedure, 149-151

Specimens, 143-144

Fillet and Stud Weld Tests, 140

Preparation of Test Coupons, 138

Responsibilities, Code User, 137-138

Specimen Removal, 140-141

Tension Test

Acceptance Criteria, 151-153

Methodology, 141

Multiple Specimens, 148-149

Procedure, 144-146

Specimen Dimensions, 142

Turned Specimen, 147

Type and Number of Test Specimens, 138-139

## R

## Repair and Buildup

- see Procedure Qualification Record (PQR), Preparing and Reviewing a PQR*
- see Welding Documentation Forms, Sample WPS, PQR and WPQ Forms*

## S

## Section IX

- Definitions QW-490, 73
- Organization of, 9-10
- Scope of, 9
- Summary of Articles
  - Article I - General Requirements QW-100, 10, 25-28
  - Article II - Procedure Qualifications QW-200, 10-11, 28-32
  - Article III - Performance Qualifications QW-300, 11, 32-35
  - Article IV - Welding Data QW-400, 11-12, 37-73
  - Article V – Standard Welding Procedure Specification (SWPS) QW-500, 12, 257-271

## SFA Specification

- see Filler Metals*
- Supplementary Essential Variables
  - Filler Metal Classification 245-246

## SI Units

- see International System of Units (SI)*

## Standard Welding Procedure Specifications (SWPS)

- Sample SWPS ANSI/AWS B2.1-1-026-94, 367-379
- see also Welding Documentation Forms, Standard Welding Procedure Specifications (SWPS)*

## Supplementary Essential Variables

- Base Metal Thickness, Minimum, 244-245
- Combination of Supplementary Essential Variables, 249
- Current and Polarity, 251
- Filler Metal Classification, SFA Specification, 245-246
- Group Numbers within P-Numbers, 242-243
- Heat Input, Control, QW-409.1, 250-251
- History of Supplementary Essential Variables, 241
- Interpass Temperature, Maximum, 247-248
- Notch-toughness, 240
- Notch-toughness Tests, 239-240
  - Additional Qualification Rules, 255-256
  - Charpy V-Notch
    - Impact Test Requirements, 253-255
    - Location of Specimens, 252-253
- Positions, 247
- Postweld Heat Treatment, 250
- Welders, 256

Système International d'Unités  
*see International System of Units (SI)*

## T

Tack Welding, 280-283

Tension Test

- Welding Procedure Qualification,
  - Acceptance Criteria, 151-153
  - Methodology, 141
  - Multiple Specimens, 148-149
  - Procedure, 144-146
  - Specimen Dimensions, 142
  - Turned Specimens, 138-139

Technique

- Welding Procedure Specification (WPS), 107-108  
*see also Welding Documentation Forms, Sample WPS, PQR and WPQ Forms*

## V

Variables

- see Procedure Qualification Record (PQR), Preparing and Reviewing a PQR, Variables*
- see Welder Performance Qualification (WPQ), Preparing and Reviewing a WPQ, Filler Metal, Thickness of Weld, Welding Variables for Welders*
- see Supplementary essential Variables*
- Variables, 39-42
- Variables for Welding Operators, 235-238

## W

Weld

- Thickness “t” for WPS and PQR, 56-61, 115-118, 125-127
- Thickness “t” for WPQ, 62-67, 196-205

Welder

- see Welder Performance Qualification*
- Supplementary Essential Variables, 256

Welder Performance Qualification (WPQ)

- see Welding Documentation Forms, Sample WPS, PQR and WPQ Forms*
- Expiration of Welder Qualification QW-322, 225-226
- Pipe Diameters, 67-69
- Positions, 69-73
- Preparing and Reviewing a WPQ
  - Base Metal QW-403
    - P-Numbers, 182-186
    - Pipe Diameters, 203-205

## Welder Performance Qualification (WPQ) (Continued)

## Preparing and Reviewing a WPQ (Continued)

## Filler Metal QW-404

F-Numbers, 186-189

Thickness of Weld, 196-202

Combination of Weld Thickness ( $t_d$ ) and Pipe Diameter, 203-205

Welding Variables for Welders, 196-202

## Joints QW-402

Backing, 205-209

## Positions QW-405, 189-194

## Renewal of Welder Qualification QW-322, 225-229

## Retests

Mechanical Examination QW-321.2, 228

Radiography QW-321.3, 228-229

Record of WPQ Tests, 229-230

Training QW-321.4, 229

Visual Examination QW-321.1, 228, 231

Welder's Log, 231-234

## Testing and Examination Requirements for WPQ

Alternate Processes and Materials, 221-222

Alternate Radiographic Acceptance Criteria, 223

## Bend Testing

Acceptance Criteria, 219-221

Bend Specimens, 216-217

Bend Test Jigs, Dimensions, 217-218

Specimen Thickness and Bend Radius, 219

## Mechanical Tests, 212, 217

Alternate to Mechanical Tests, 221

PQR Test Coupon Qualifies Welder, 224

Responsibilities, 212

Specimen Removal, 215-216

Test Coupon Requirements, 212-213

Type and Number of Tests, 213-214

Visual Examination, 214-215

Visual Tests, 212

Welder Performance Qualification (WPQ) Records, 224

Welder's Test Options, 212

## Welding Procedure Specification (WPS), 13-14

*see Base Metal, Thickness "T" for WPS and PQR**see Weld, Thickness "t" for WPS and PQR**see Welding Documentation Forms, Sample WPS, PQR and WPQ Forms**see Procedure Qualification Record (PQR), Preparing and Reviewing a PQR, Combination Welding Procedure*

Welding Procedure Specification (WPS) (Continued)

Checklist, 155-180

Documentation Review Certification, 180

Gas Metal-Arc Welding, 161-162

Gas Tungsten-Arc Welding, 159-160

PQR Audit Checklist, 176-178

PQR Supporting the WPS Qualification Audit, 178-180

Shielded Metal-Arc Welding, 157-158

Submerged-Arc Welding, 163-164

WPS Audit Checklist, 173-175

Preparing and Reviewing a WPS, 85-108

Joints QW-402

Groove Design, 89-91

Backing, Root Spacing, Retainers, 91-95

Base Metal QW-403, 96-97

*see also Base Metal*

Electrical QW-409, 105-106

Filler Metal QW-404, 98-101

Positions QW-405, 102

Postweld Heat Treatment, 104-105

Preheat QW-406, 103-104

Technique, 107-108

Welding Data

*see Section IX, Summary of Articles, Article IV*

*see Variables*

Welding Documentation Forms

Nonmandatory Welding Forms, 15

Procedure Qualification Record (PQR), 14

QW-482 Form, 18-19

QW-483 Form, 20-21

QW-484 Form, 22-23

QW-485 Form, 24

Sample WPS, PQR and WPQ Forms, 75-84

Section IX Appendix B, 15

Standard Welding Procedure Specifications (SWPS), 14-15

Suggested Report Forms, 16-17

Welders Performance Qualification (WPQ), 14

Welding Procedure Specification (WPS), 13-14

## CODE PARAGRAPH INDEX

QB-100	10, 284	QW-153.1(d)	145, 152, 178
QB-100.1	284	QW-160	21, 26, 28, 139, 142, 158, 160, 162, 164, 170, 172, 217, 219, 267
QB-200	10	QW-161	26, 142, 150, 291, 294, 295
QB-300	10	QW-161.1	143, 217
QB-400	10	QW-161.2	217
QB-402.2	286	QW-161.3	217
QB-403	286	QW-161.4	217
QB-403.2	285	QW-161.5	217
QB-408	285	QW-162	26, 218
QB-461	285	QW-162.1	28, 149, 217
QB-462	285	QW-163	26, 153, 177, 219, 220
QB-492	284	QW-170	21, 26, 28, 157, 158, 160, 162, 164, 170, 172, 219, 239
QW-100	8, 10, 11, 25, 26	QW-171	239
QW-100.1	14, 25, 26	QW-171.1	239
QW-100.2	26	QW-171.2	239
QW-100.3	26, 27, 82, 277	QW-171.3	239
QW-101	7	QW-180	21, 22, 23, 28, 170, 219
QW-102	7	QW-181.1	26
QW-103	26	QW-181.1.1	61, 62
QW-103.1	26, 27	QW-181.2	26
QW-103.2	14, 15	QW-184	22, 23
QW-110	26, 27	QW-190	28, 214
QW-120	26, 27, 69, 102, 189, 192	QW-191	22, 23, 26, 28, 223, 236, 264, 267
QW-130	69, 102, 189, 192	QW-191.1	223, 237
QW-140	26, 28	QW-191.2	223
QW-142	26, 221, 223	QW-191.2.1	223
QW-143	236	QW-191.2.2	223, 227
QW-144	26	QW-191.2.3	223, 227
QW-150	21, 26, 28, 80, 139, 141, 158, 160, 162, 164, 170, 172	QW-192	28
QW-151	139, 141	QW-192.2	223
QW-151.1	57, 142	QW-193	28, 237
QW-151.1(a)	142, 146	QW-194	26, 28, 267
QW-151.1(b)	146	QW-195	26, 28, 291, 294
QW-151.1(c)	141, 146, 148	QW-195.2	291
QW-151.1(d)	146	QW-196	26, 28, 237
QW-151.2	57	QW-196.2	291
QW-151.3	57, 147	QW-197	28
QW-151.3(b)	148	QW-198	28
QW-152	144, 147	QW-200	10, 25, 28, 208, 224
QW-153	44, 47, 48, 129, 130, 141, 185	QW-200A	280
QW-153.1	151, 177		

**390 Code Paragraph Index**

QW-200A(b)	287	QW-203	29
QW-201	27, 30, 109, 157, 158, 160	QW-203.3	120
QW-200.1	13, 18, 28, 29, 167, 240	QW-210	29
QW-200.1(a)	13, 14, 15, 17, 28	QW-211	30, 79, 129, 138, 141
QW-200.1(b)	13, 86, 87, 155	QW-212	41, 79
QW-200.1(c)	13, 86, 91, 95, 275	QW-213	29, 30
QW-200.1(d)	14, 15, 85	QW-214	30, 289
QW-200.1(e)	14, 15, 28	QW-214.1	289
QW-200.2	14, 20, 29, 169, 180	QW-214.2	289
QW-200.2(a)	14	QW-216	289
QW-200.2(b)	14, 109, 110	QW-218	29, 30
QW-200.2(c)	14, 82, 129	QW-250	2, 10, 14, 16, 29, 30, 31, 39, 40, 75, 85, 109, 155, 156, 164, 240, 241, 268, 289
QW-200.2(d)	14, 15	QW-253	14, 29, 30, 31, 32, 39, 41, 44, 56, 59, 87, 88, 89, 90, 91, 96, 97, 98, 102, 104, 105, 107, 109, 110, 111, 114, 115, 119, 120, 125, 130, 131, 184, 195, 208, 240, 241
QW-200.3	29, 49, 239, 240	QW-253.1	30, 289, 290, 293
QW-200.4	29, 57, 113, 122, 123, 139, 156, 158, 160, 162, 164, 172, 175, 177, 242, 280, 281, 287	QW-256	209
QW-200.4(a)	123, 147, 175, 180, 255, 256, 286, 287, 288	QW-280	14, 16, 240
QW-200.4(b)	29, 123, 175, 180, 271, 286, 287, 288	QW-283	29, 31
QW-201	29, 109, 137, 138, 162, 164, 172, 178	QW-284	29, 31
QW-202	29, 111, 112	QW-286	31
QW-202.1	30, 138, 139, 140	QW-300	10, 11, 25, 32
QW-202.2	29, 30, 56, 57, 60, 61, 62, 111, 112, 113, 115, 118, 156, 158, 160, 162, 164, 171, 177	QW-300.1	32, 33, 212
QW-202.2(a)	61, 111, 112, 115, 117, 120, 140, 175, 180, 201, 282	QW-300.2	27, 32, 33, 212
QW-202.2(b)	58, 61, 111, 112, 115, 117, 120, 140, 201, 282	QW-300.3	33
QW-202.2(c)	61, 111, 112, 115, 117, 140, 282	QW-301	22, 33, 226, 228
QW-202.2(d)	140	QW-301.2	14, 33, 81, 141, 208, 204, 224
QW-202.3	30, 57, 112, 113, 119, 120, 156, 158, 160, 162, 164, 172, 175, 177, 180	QW-301.3	33
QW-202.3(a)	112	QW-301.4	14, 15, 33, 208, 224
QW-202.3(b)	112	QW-302	33, 62, 226, 279
QW-202.4	30, 57, 112, 113, 116, 119, 120, 122, 156, 158, 160, 162, 164, 172, 175, 177, 180	QW-302.1	33, 62, 212, 213, 215, 217, 219, 221, 236, 267
QW-202.4(a)	112	QW-302.2	33, 192, 221, 222, 223, 228, 236, 267
QW-202.4(b)	31, 96, 110, 112	QW-302.3	33, 64, 214
QW-202.5	140	QW-302.4	22, 23, 33, 64, 81, 83, 212, 214, 215, 220, 221, 225, 228, 236, 267
		QW-303	33, 72, 102, 189, 192, 193, 208
		QW-303.1	69, 193, 194, 195, 196
		QW-303.2	69, 193, 194, 195, 196

QW-304	14, 32, 33, 208, 212, 221, 223, 226, 228, 231, 232, 233, 235, 236, 267, 279	QW-381(c)	295
		QW-381(d)	295
QW-304.1	223, 228, 236	QW-382	34, 237
QW-305	33, 34, 226, 235, 236	QW-383	237
QW-305.1	236	QW-383(c)	295
QW-306	33, 34, 123, 196, 212	QW-384	237
QW-310	33, 34	QW-400	10, 11, 32, 37, 40, 41, 241
QW-310.1	64, 212	QW-401	7, 38, 40, 41, 76, 79, 87, 156, 158, 160, 162, 164, 172, 175
QW-310.2	212	QW-401.1	37, 38, 40, 240
QW-310.3	212	QW-401.2	37, 40
QW-320	33, 34	QW-401.3	38, 40, 73, 240, 242, 243, 244, 249, 251, 252, 294
QW-321	229	QW-401.4	37, 38, 40
QW-321.1	228	QW-402	8, 18, 20, 31, 32, 37, 38, 40, 88, 89, 91, 92, 156, 167, 169, 205
QW-321.1(a)	231	QW-402.1	8, 32, 41, 76, 88, 89, 90, 91, 157, 159, 161, 163, 171, 173, 180
QW-321.2	228	QW-402.2	73
QW-321.3	228	QW-402.4	32, 34, 35, 39, 41, 76, 77, 81, 88, 91, 93, 94, 95, 157, 159, 161, 163, 171, 173, 182, 205, 207, 208, 209, 229, 271, 295
QW-321.4	229	QW-402.5	95
QW-322	33, 225, 228, 236	QW-402.7	207
QW-322.1	231, 336	QW-402.10	76, 88, 91, 93, 157, 159, 161, 163, 171, 173, 278
QW-322.1(a)	225, 226, 231, 232, 233	QW-402.11	73, 76, 88, 91, 93, 94, 95, 157, 159, 161, 163, 171, 207
QW-322.1(b)	226, 228, 230	QW-402.16	290, 292, 293
QW-322.2(a)	225, 226, 227, 231, 233	QW-403	18, 20, 31, 77, 88, 96, 97, 110, 111, 115, 125, 129, 167, 169, 175, 194
QW-322.2(b)	226	QW-403.2	57, 58, 59, 113
QW-350	2, 11, 22, 32, 33, 34, 39, 40, 41, 75, 112, 120, 122, 181, 193, 196, 224, 237, 283, 295	QW-403.3	57, 58, 113
QW-351	14, 63, 64, 196, 197, 200, 201, 202	QW-403.5	47, 242, 243, 258
QW-352	194, 207	QW-403.6	57, 59, 113, 243, 244
QW-353	14, 32, 35, 39, 41, 45, 62, 67, 181, 182, 183, 184, 189, 195, 196, 208, 295	QW-403.7	57, 59, 76, 79, 96, 97, 110, 111, 112, 113, 114, 115, 118, 119, 122, 125, 127, 156, 157, 159, 161, 163, 171, 173, 179, 156, 286, 288
QW-356	209	QW-403.8	32, 39, 56, 60, 61, 79, 96, 97, 110, 111, 112, 114, 115, 118, 119, 122, 125, 127, 156, 157, 159, 161, 163, 171, 198
QW-357	14		
QW-360	32, 33, 34, 237		
QW-361	237		
QW-361.1	23, 236, 237		
QW-361.2	23, 235, 237		
QW-362	237		
QW-363	237		
QW-380	34, 237, 295		
QW-381	237		
QW-381(a)	295		
QW-381(b)	295		



**392 Code Paragraph Index**

QW-403.9	4, 57, 59, 77, 79, 96, 97, 110, 111, 113, 115, 119, 122, 125, 127, 129, 157, 161, 163, 171, 173, 176, 179	QW-404.12(e)	245, 275
QW-403.10	57, 113, 127, 161, 280	QW-404.14	159
QW-403.11	43, 44, 46, 49, 76, 79, 96, 97, 110, 111, 115, 119, 122, 125, 127, 156, 157, 159, 161, 163, 171, 176, 184, 242, 288	QW-404.15	34, 35, 41, 50, 51, 81, 182, 186, 187, 188, 196, 203, 229, 270
QW-403.13	44, 77, 96, 97, 110, 111, 115, 119, 122, 125, 127, 156, 157, 159, 161, 163, 171, 173, 176, 179, 288	QW-404.22	4, 159, 209
QW-403.16	27, 34, 35, 39, 41, 67, 69, 81, 181, 182, 194, 195, 203, 204, 209, 229, 270, 289	QW-404.23	159, 161
QW-403.18	34, 35, 43, 45, 46, 49, 81, 182, 183, 184, 209, 229, 270	QW-404.24	161, 163
QW-403.20	289, 290, 293	QW-404.27	161, 163, 289
QW-403.23	289, 293	QW-404.29	16, 163
QW-403.32	279	QW-404.30	34, 35, 39, 56, 60, 61, 62, 66, 76, 79, 81, 97, 98, 110, 111, 112, 114, 118, 119, 122, 125, 126, 157, 159, 161, 163, 171, 182, 186, 196, 198, 203, 204, 229, 270
QW-404	16, 18, 20, 31, 88, 97, 98, 110, 111, 122, 125, 167, 169, 176, 186, 196, 271	QW-404.32	113, 161, 279, 280
QW-404.3	159	QW-404.33	76, 79, 97, 98, 99, 129, 157, 159, 161, 163, 165, 171, 174, 275
QW-404.4	41, 50, 51, 55, 61, 76, 79, 97, 98, 110, 111, 119, 122, 125, 129, 130, 157, 159, 161, 163, 171, 179, 187, 188	QW-404.34	163
QW-404.5	16, 53, 54, 55, 76, 79, 80, 97, 98, 110, 111, 119, 122, 125, 129, 157, 158, 159, 160, 161, 162, 163, 164, 165, 171, 172, 174, 178, 179	QW-404.35	16, 163
QW-404.5(a)	53	QW-404.36	16, 163
QW-404.5(b)	53, 54	QW-404.37	289, 293
QW-404.5(c)	53	QW-404.38	289, 293
QW-404.6	97, 98, 157, 161, 163, 171	QW-404.50	159
QW-404.9	16, 163	QW-405	20, 31, 79, 88, 102, 168, 169, 182, 189
QW-404.9(b)	16	QW-405.1	34, 35, 76, 81, 102, 156, 157, 159, 161, 163, 171, 182, 189, 191, 192, 194, 205, 229, 247, 270
QW-404.9(c)	16	QW-405.2	247
QW-404.9(d)	16	QW-405.3	34, 35, 81, 102, 157, 159, 161, 171, 182, 189, 191, 192, 209, 229, 270
QW-404.10	16, 163, 187	QW-405.4	289, 293, 295
QW-404.12	245, 246, 273, 275, 289, 293	QW-406	20, 31, 88, 103, 130, 168, 169, 251
QW-404.12(a)	245	QW-406.1	76, 79, 103, 110, 130, 157, 159, 161, 163, 171, 179, 249, 251, 265, 294
QW-404.12(b)	245	QW-406.2	76, 103, 157, 161, 163, 171, 174
QW-404.12(c)	245	QW-406.3	73, 103, 104, 247, 249, 251, 265, 294
QW-404.12(d)	245	QW-406.4	289, 294
		QW-407	16, 20, 31, 88, 104, 105, 131, 132, 161, 168, 169, 176

QW-407.1	73, 77, 79, 104, 105, 110, 131, 132, 134, 135, 157, 159, 161, 163, 171, 174, 176, 177, 180	QW-420.2	38, 48, 49, 50, 182, 183, 184, 185
QW-407.1(a)	132	QW/QB-422	5, 38, 42, 43, 44, 45, 46, 47, 48, 49, 56, 176, 177, 182, 185, 186, 293
QW-407.2	133, 252, 294	QW-423	43, 44, 45, 46, 49, 81, 182, 183, 185
QW-407.4	57, 77, 79, 104, 105, 110, 113, 131, 132, 134, 157, 159, 161, 163, 171, 177, 180	QW-423.1	45, 46, 182, 183, 270
QW-407.6	289, 294	QW-424	43, 44, 45, 46, 47, 49, 96, 127, 179, 184, 185
QW-408	20, 95, 168, 169	QW-424.1	45, 46
QW-408.1	159, 161	QW-430	37, 50, 122
QW-408.2	159, 161	QW-431	38, 51, 52
QW-408.3	159, 161	QW-432	38, 41, 50, 51, 52, 55, 97, 150, 186, 188, 293
QW-408.5	95, 159, 161	QW-433	41, 50, 51, 52, 179, 186, 187, 188, 200, 203, 230
QW-408.8	94, 207	QW-440	37, 53
QW-408.9	159, 161	QW-441	38
QW-408.10	159, 161	QW-442	38, 52, 53, 54, 55, 97, 129, 176, 186, 187
QW-409	19, 20, 31, 88, 105, 166, 168, 169, 180	QW-450	37
QW-409.1	252, 253, 255	QW-451	11, 29, 30, 31, 38, 56, 62, 66, 96, 97, 110, 111, 112, 115, 117, 119, 122, 123, 126, 129, 138, 139, 148, 177, 198, 204, 287, 288
QW-409.2	161, 279	QW-451.1	5, 7, 56, 57, 58, 59, 60, 61, 62, 112, 113, 115, 119, 124, 126, 132, 133, 138, 139, 140, 141, 142, 147, 157, 158, 160, 162, 164, 172, 177, 179, 215, 280, 287
QW-409.3	159	QW-451.2	56, 62, 139
QW-409.4	76, 98, 105, 157, 159, 161, 163, 171, 253, 289, 294	QW-451.3	56, 61, 62, 140
QW-409.8	76, 98, 105, 157, 159, 161, 163, 171	QW-451.4	56, 61, 62, 140
QW-409.12	159	QW-452	11, 27, 38, 41, 56, 60, 62, 63, 66, 67, 69, 114, 194, 195, 196, 198, 200, 201, 204, 213, 214, 216, 224
QW-409.22	289, 294	QW-452.1	56, 62, 63, 64, 65, 66, 67, 68, 69, 81, 83, 194, 196, 197, 198, 199, 200, 203, 204, 205, 213, 215, 220, 288
QW-410	19, 20, 31, 37, 38, 40, 41, 88, 107, 156, 166, 168, 169, 180	QW-452.2	62
QW-410.1	76, 107, 157, 160, 162, 164, 171	QW-452.3	41, 64, 67, 68, 69, 72, 194, 195, 196, 197, 203, 204
QW-410.3	160, 162	QW-452.4	63, 68, 72, 193, 195, 196
QW-410.5	76, 107, 157, 160, 162, 164, 171	QW-452.5	63, 72, 193, 194, 195, 196
QW-410.6	107, 157, 160, 162, 164, 171	QW-452.6	63, 193, 194, 195, 196
QW-410.7	160, 162, 164		
QW-410.8	162, 164		
QW-410.9	107, 157, 160, 162, 164, 171, 175		
QW-410.10	160, 162, 164		
QW-410.11	160		
QW-410.15	160, 162, 164		
QW-410.25	87, 107, 157, 160, 162, 164, 171		
QW-410.26	76, 107, 157, 160, 162, 164, 171		
QW-410.38	289, 290, 294		
QW-420	37, 43, 185		
QW-420.1	38, 43, 47, 48		

**394 Code Paragraph Index**

QW-453	289, 290, 291, 292, 293, 294, 295	QW-466.1	69, 142, 149, 150, 151, 217, 218, 219, 220
QW-461	71	QW-466.2	70, 150, 217, 218
QW-461.1	7, 26, 27, 28, 33, 37, 38, 70, 71, 72, 193	QW-466.3	28, 149, 150, 217, 218
QW-461.2	27, 28, 72, 193	QW-466.4	150
QW-461.3	26, 27, 38, 69, 70	QW-469.1	212
QW-461.4	37, 69, 70	QW-469.2	212
QW-461.8	27, 38	QW-470	37, 38, 153, 256
QW-461.9	7, 11, 27, 33, 37, 38, 71, 72, 102, 189, 190, 192, 193, 230	QW-472	152
QW-462	38, 146, 216	QW-482	7, 13, 15, 16, 18-19, 85, 86, 87, 88, 93, 95, 165, 167, 168
QW-462.1	141, 142	QW-483	13, 15, 17, 20-21, 138, 144, 145, 146, 165, 169, 170, 178
QW-462.1(a)	141, 142	QW-484	13, 15, 17, 22, 23, 181, 209, 238
QW-462.1(b)	142	QW-484B	238
QW-462.1(c)	142	QW-485	10, 12, 13, 15, 24, 263, 264
QW-462.1(d)	142, 147	QW-490	73, 92
QW-462.1(e)	142, 149	QW-492	37, 38, 73
QW-462.2	22, 23, 24, 64, 143, 153, 170, 214, 216, 264	QW/QB-492	55
QW-462.3	143, 153, 217	QW-500	10, 12, 25, 258
QW-462.3(a)	22, 23, 24, 64, 80, 81, 153, 214, 220, 264	QW-510	261, 267, 269
QW-462.3(b)	22, 23	QW-510(a)	261
QW-462.3(d)	192	QW-510(b)	261
QW-462.3(e)	192	QW-510(c)	261
QW-462.4(a)	62	QW-510(d)	14, 73, 261, 263, 265, 267
QW-462.4(d)	62	QW-510(e)	15, 267
QW-462.5	292, 293	QW-520	267, 268
QW-462.5(a)	290, 291, 292, 293, 295	QW-520(a)	268
QW-462.5(b)	22, 23, 290, 291, 294	QW-520(b)	268
QW-462.5(c)	22, 23, 290, 291, 294, 295	QW-520(c)	268
QW-462.5(d)	22, 23, 290, 291, 294, 295	QW-520(d)	268
QW-462.5(e)	22, 23, 290, 291, 294	QW-520(e)	268
QW-463	38, 62, 140	QW-520(f)	268
QW-463.1(a)	139, 140, 142	QW-520(g)	268
QW-463.1(b)	139	QW-530	15
QW-463.1(d)	140	QW-540	269
QW-463.1(e)	140	QW-540(a)	269
QW-463.1(f)	239, 240	QW-540(b)	269
QW-463.2	213, 215, 216	QW-540(c)	269
QW-463.2(a)	216	QW-540(d)	269
QW-463.2(b)	216	QW-540(e)	269
QW-463.2(f)	192, 212, 216	QW-540(f)	267, 269
QW-463.2(g)	192, 212, 216	QW-540(g)	267, 269
QW-466	38, 149, 150, 218	QW-540(h)	269

# **ASME INTERPRETATIONS INDEX**

<b>Interpretation</b>	<b>Paragraph<sup>(a)</sup></b>	<b>Subject</b>	<b>Page(s)</b>
IX-77-01	QW-462.1	Machining tensile sample below original surface	142
IX-77-04		Section IX, Tack Welder Qualification	283
IX-77-19	QW-351	Welder qualification based on weld thickness	50, 197
IX-78-21	QW-201.3	Combination of Welding Processes or Procedures	123
IX-78-67	QW-442	Weld Metal Chemistry	55
IX-78-74	QW-407.1	Qualification of Seal Welds	136
IX-78-76	QW-153(d)	Tension Test Acceptance Criteria	145
IX-78-86	QW-305	Welder versus Welding Operator, SAW Process	236
IX-79-01	QW-103.2	Retention of Qualification Specimens and Radiographs	224
IX-79-25	QW-402.2 & .4	Welder Qualification for Split Backing Rings	222
IX-79-30	QW-100.3	Pre 1962 Edition and Subsequent Changes	27
IX-79-35	QW-304 & 305	SAW Welder versus Welding Operator	236
IX-79-43	QW-153	Welding Qualification Mechanical Properties	145
IX-79-68	QW-304 & 305	Semi-automatic Welding Welder versus Welding Operator	236
IX-79-79	QW-200	Preparation of a WPS & Nonessential Variables on a PQR	136
IX-79-85	QW-407.4	PWHT above the Critical (Transformation) Range	133
IX-79-88	QW-451.1	Combination Process WPS Thickness Range	125
IX-80-04	QW-201.3 & 403.6	Minimum Thickness for Multiple Procedures	4, 244
IX-80-06	QW-252 through 260	Qualification of Tube-to-Tubesheet Welds	196
IX-80-08	QW-452.3	Small Diameter "Saddle-In" versus "Saddle-On"	67, 60, 195
IX-80-09	QW-407.1	PWHT Temperature Qualification Range	136
IX-80-10	QW-453 Note 9	Chemical Analysis (formerly QW-216.2(d))	4
IX-80-11	QW-200.1(b) & (d)	Two or More WPS Documents	293
IX-80-12	QW-351	Change in "A" Number for Welder Qualification	187
IX-80-17	QW-200.1 & .2	Contents of WPS & PQR	136
IX-80-18	QW-452.3	Small Diameter "Saddle-In" versus "Saddle-On"	195
IX-80-19	QW-201 & 300.2	Companies with Different Names & Divisions	30, 32
IX-80-22	QW-351	Change in "A" Number for Welder Qualification	187
IX-80-31	QW-202.2	Qualification of Dissimilar Base Metal Thickness	115
IX-80-32	QW-463.2(f)	Combination 2G plus 5G Pipe Test Coupon	192, 223
IX-80-41	QW-451.2	Multiple Process Impact Tested PQR	256
IX-80-49	QW-202.4	Dissimilar Base Metal Thickness Qualifications	125
IX-80-50	QW-452.1	Welders Base Metal Thickness Qualification	199
IX-80-66	QW-202.2 & 301.2	Qualification for Tack Welds	282
IX-80-67	QW-452.3	Nozzle to Shell Connections	195
IX-81-02	QW-200.4	Combination Process Qualification	281
IX-81-11	QW-200.4	Combination Process Qualification	125
IX-81-27	QW-322	Welders versus Welding Operators	236
IX-81-28	QW-351	Multiple Welders in a Single Weld Groove	201
IX-81-33	QW-150 & 451	PQR Base Metal Thickness Based on Test Coupon	146
IX-81-38	QW-202.4	Dissimilar Base Metal Thickness Test Coupons	121

Interpretation	Paragraph <sup>(a)</sup>	Subject	Page(s)
IX-81-45	QW-100.3	PQR Qualifications to Date of Contract	27
IX-81-47	QW-322	Maintenance and Renewal of Qualification	229
IX-82-02	QW-402.1	All Groove Designs	90
IX-82-05	QW-452.3	Set-on Nozzles, thickness and position	195
IX-82-07	QW-452.3	Procedure and Performance diameter limitations	195
IX-82-17	QW-403.9	GMAW-S limitation on weld metal thickness	127
IX-82-19	QW-452.3	Set-on Nozzles, fillet welded	195
IX-83-11	QW-403.11, QW-407.4	PWHT above the transformation temperature	136
IX-83-13	QW-321, QW-304	Welder training after failed performance test	223
IX-83-18	QW-451.1, QW-403.10	GMAW Short-circuiting combined with other process	281
IX-83-26	QW-409.8, QW-200.2(b)	Amps, volts and tensile test recording on a PQR	145
IX-83-33	QW-409.1	Heat input control when austenitizing heat treat applied	253
IX-83-78	QW-450 vs. QW-461	Weld metal thickness vs. test specimen thickness	57, 64
IX-83-90	QW-452.1, QW-351	Welder limits on weld metal thickness	201
IX-83-92	QW-403.5	Notch-toughness P-Number, Group Number	242
IX-83-94	QW-451.1	PQR based on test coupon or test specimen thickness	146
IX-83-100	QW-403.18, QW-404.22	Welders base metal and consumable insert	209
IX-83-103	QW-2022, QW-301.2	Pressure retaining fillet weld qualifications	194
IX-83-106	QW-403.11, QW-403.18	Base metal qualification for WPQ & PQR	45
IX-83-130	QW-407.1	PQR PWHT soak time consideration	118
IX-83-158	QW-452.1, QW-351	Welder weld metal thickness qualification	201
IX-83-159	QW-322.1	Maintenance of welders qualification on non-code work	231
IX-83-166	QW-322	Maintenance of welders qualification using one WPS	231
IX-83-167	QW-322	Maintenance of welders qualification on non-code work	231
IX-83-172	QW-200.1, QW-200.2	Recording QW403.9, & consumable insert details	4, 127
IX-86-01	QW-200.4(a)	Combination qualification then using one of the processes	125
IX-86-03	QW-404		50
IX-86-08	QW-200.4(a)	Combining separate WPSs	125
IX-86-14	QW-407.1	The use of "NA" on a WPS & PQR	133
IX-86-20	QW-407	Is post heating considered PWHT	136
IX-86-47	QW-407.1(b)	Inadvertent PWHT of P-Number 43	136
IX-86-51	QW-403.18, QW-423	Welder Performance Qualification base metal	183
IX-86-79	QW-304.1, QW-302.2	Length of performance test coupon for RT examination	222
IX-86-89	QW-202.4, QW-451	Both the thicker and thinner base metals shall be qualified	115
IX-89-03	QW-200.1, QW-350	Listing and using variables	85, 181
IX-89-05	QW-424	Non pressure attachment materials	45
IX-89-06	QW-452.1, QW-351	Stacking welders to complete a weld	201
IX-89-12	QW-202.3	Groove weld PQR for CRWMO	289
IX-89-15	QW-423	Base metals for welder performance qualification	183
IX-89-28	QW-402.4	Combination F-Numbers for VVTQ	207
IX-89-52	QW-452.1	Weld metal thickness = maximum to be welded	199
IX-89-65	Section II Part C	SFA 5. 1, Paragraph 6. 1. 1, marking filler metal containers	99
IX-89-86	QW-403.6	Weld metal or base metal thickness limitation	244
IX-89-96	QW-403.6, QW-451	Weld metal or base metal thickness limitation	244
IX-89-98	QW-303, QW-461.9	Position and diameter limitations	68

Interpretation	Paragraph(a)	Subject	Page(s)
IX-89-100	QW-202.2, QW-451	Minimum and maximum base metal thickness	4, 244
IX-89-100R	QW-202.2, QW-451	Minimum and maximum base metal thickness	245
IX-89-104	QW-452.3	No maximum outside diameter	68
IX-92-07	QW-201	Code users responsibilities	30
IX-92-09	QW-103.1	Contractor providing WPSs for subcontractor	27
IX-92-15	QW-303, QW-461.9	Performance qualification position and diameter limitations	68
IX-92-16	QW-103.1, QW-200.2(b)	Code users responsibilities	27, 29
IX-92-21	QW-404.12	Change in filler metal	245
IX-92-28	QW-453, QW-250	CRWMO essential variables	212
IX-92-36	QW-452.1	Bend tests, thickness limits and specimens	201
IX-92-40	QW-409.1	Heat input methods for notch toughness qualification	253
IX-92-41	QW-461.9	Plate does not qualify for pipe	68
IX-92-42	QW-200.4(a)	Combination processes or procedures for toughness tests	256
IX-92-43	QW-492	Definition of Machine Welding	237, 238
IX-92-47	QW-322.2	Renewal of performance qualification on production work	233
IX-92-59	QW-452. 1, QW-452.3	Combination weld metal thickness and pipe diameters	203
IX-92-69	QW-409.1	Heat input based on location of impact test specimens	255
IX-92-71	QW-302.4	Visual examination prior to 1992 addenda	27
IX-92-72	QW-3810, QW-453, QW-461.9	CRWMO	295
IX-92-77	QW-200.4, QW-451.4	Combination welding procedures & Fillet weld qualifications	125
IX-92-78	QW-200.2(b)	Code users subcontracting certification of PQRs	29
IX-92-79	QW-151.1, QW-462.1(a)	Reduction of test specimen thickness for testing	142
IX-92-80	QW-103, QW-201	Code users responsibility	30
IX-92-87	QW-403.6, QW-409.1	Heat input based upon two notch toughness PQRs	4, 253
IX-92-90	QW-461.9, QW-452.3	Performance qualification combination position and diameter	68
IX-92-97	QW-200.4(a)	Using combination process WPS for a single process	125
IX-95-02	QW-462	Approximate dimensions of test specimens	142
IX-95-03	QW-202.2, QW-202.3	Partial penetration, repairs and buildup	119
IX-95-06	QW-153.1	Tension test breaks in the weld metal	145, 152
IX-95-08	QW-462.4(a)	Fillet weld sizes	93
IX-95-10	QW-200.4	Combination PQR supports single process WPS	123
IX-95-12	QW-202.4	Dissimilar base metal thickness for butt and comer joints	119
IX-95-20	QW-300	Contracted employee under Code Users supervision	29
IX-95-25	QW-201	Company A buys Company B and uses their PQRs	32
VIII-1-80-04	UW-31(c)	Extent of removal of tack weld	283
VIII-1-80-17	UCL-23(c)	CRWMO may be used in determining the required thickness	295
VIII-1-83-107	UCL-35(c)	CRWMO dilution and repair of defects	295
VIII-1-83-255	UW-39, AF-234	Peening	109
VIII-1-83-331	UW-31(c)	Satisfactory tackweld ends produced by weld process	283
VIII-1-86-116	UW-31(c)	Backing subject to stress due to pressure	96

<b>Interpretation</b>	<b>Paragraph(a)</b>	<b>Subject</b>	<b>Page(s)</b>
VIII-1-92-51	UG-84(h)(3)(b)	Same heat treated condition	258

- a. Over the years, some of the Code paragraph numbers have changed or may no longer exist. These interpretations remain valid, despite the change or removal of the original referenced paragraph. Every effort was made to include the proper code reference where possible.

## **ABOUT THE AUTHORS**



Michael J. Houle earned his Bachelor of Science degree in Mechanical Engineering (BSME) in 1957 from Michigan Technological University. He has more than 40 years of industrial experience in the field of welding with extensive involvement in the development of quality, training, fabrication, and repair programs. Mr. Houle has eight years of regulatory experience as Director of Welding for the National Board of Boiler and Pressure Vessel Inspectors with duties which included reviewing applicants for ASME and National Board Certification, training of Authorized Inspectors, and investigations of companies and products.

Mr. Houle organized Welding Engineering Services in 1987 and quickly established a wide range of clients in the power, petrochemical, paper, manufacturing, repair and insurance industries throughout the world. He currently develops and presents seminars on AWS, ASME, API, NBIC, and R Stamp Repair codes and standards, as well as other welding topics. He develops quality programs, welding procedures, repair plans, welder's performance qualifications, enabling procedures for quality systems, and participates in litigation involving welding codes and standards.

Mr. Houle is a very active member of the American Society of Mechanical Engineers (ASME) Welding Subcommittee IX, ASME Subgroup on Qualifications (IX), ASME Pressure Vessel Subcommittee VIII, ASME Subgroup on Fabrication and Inspection (VIII), Welding Research Council (WRC) Welding Procedure Committee, several American Welding Society (AWS) committees and is the past United States Delegate to the International Institute of Welding (IIW) Commission XI on Pressure Vessels & Piping.



Richard D. McGuire has 22 years of experience in welding engineering, NDT, quality control, and training management. Since 1987, he has served as manager of training for the National Board of Boiler and Pressure Vessel Inspectors, responsible for all National Board training and programs.

Mr. McGuire's professional associations include membership in the American Society for Nondestructive Testing (ASNT), American Welding Society (AWS), ASM International and American Society for Training and Development (ASTD). He serves on several ASME Boiler and Pressure Vessel Code committees including Section IX and AWS committees. Mr. McGuire earned a degree in welding engineering from California Polytechnic State University at San Luis Obispo.